



COMMONWEALTH OF PENNSYLVANIA
DEPARTMENT OF ENVIRONMENTAL PROTECTION
AIR QUALITY PROGRAM

STATE ONLY SYNTHETIC MINOR OPERATING PERMIT

Issue Date: May 30, 2024

Effective Date: June 1, 2024

Expiration Date: May 31, 2029

In accordance with the provisions of the Air Pollution Control Act, the Act of January 8, 1960, P.L. 2119, as amended, and 25 Pa. Code Chapter 127, the Owner, [and Operator if noted] (hereinafter referred to as permittee) identified below is authorized by the Department of Environmental Protection (Department) to operate the air emission source(s) more fully described in this permit. This Facility is subject to all terms and conditions specified in this permit. Nothing in this permit relieves the permittee from its obligations to comply with all applicable Federal, State and Local laws and regulations.

The regulatory or statutory authority for each permit condition is set forth in brackets. All terms and conditions in this permit are federally enforceable unless otherwise designated.

State Only Permit No: 28-05047

Synthetic Minor

Federal Tax Id - Plant Code: 39-0380010-1

Owner Information

Name: JOHNSON CONTROLS INC
Mailing Address: 100 CUMBERLAND VALLEY AVE
WAYNESBORO, PA 17268-1206

Plant Information

Plant: JOHNSON CONTROLS INC/WAYNESBORO
Location: 28 Franklin County 28002 Waynesboro Borough
SIC Code: 3585 Manufacturing - Refrigeration And Heating Equipment

Responsible Official

Name: TYLER J. BARNHART
Title: CI SPECIALIST
Phone: (717) 586 - 5307 Email: tyler.jacob.barnhart@jci.com

Permit Contact Person

Name: TYLER J BARNHART
Title: CI SPECIALIST
Phone: (717) 586 - 5307 Email: tyler.jacob.barnhart@jci.com

[Signature] _____
WILLIAM R. WEAVER, SOUTH CENTRAL REGION AIR PROGRAM MANAGER



SECTION A. Table of Contents

Section A. Facility/Source Identification

Table of Contents
Site Inventory List

Section B. General State Only Requirements

- #001 Definitions.
- #002 Operating Permit Duration.
- #003 Permit Renewal.
- #004 Operating Permit Fees under Subchapter I.
- #005 Transfer of Operating Permits.
- #006 Inspection and Entry.
- #007 Compliance Requirements.
- #008 Need to Halt or Reduce Activity Not a Defense.
- #009 Duty to Provide Information.
- #010 Revising an Operating Permit for Cause.
- #011 Operating Permit Modifications
- #012 Severability Clause.
- #013 De Minimis Emission Increases.
- #014 Operational Flexibility.
- #015 Reactivation
- #016 Health Risk-based Emission Standards and Operating Practice Requirements.
- #017 Circumvention.
- #018 Reporting Requirements.
- #019 Sampling, Testing and Monitoring Procedures.
- #020 Recordkeeping.
- #021 Property Rights.
- #022 Alternative Operating Scenarios.
- #023 Reporting
- #024 Report Format

Section C. Site Level State Only Requirements

- C-I: Restrictions
- C-II: Testing Requirements
- C-III: Monitoring Requirements
- C-IV: Recordkeeping Requirements
- C-V: Reporting Requirements
- C-VI: Work Practice Standards
- C-VII: Additional Requirements
- C-VIII: Compliance Certification
- C-IX: Compliance Schedule

Section D. Source Level State Only Requirements

- D-I: Restrictions
- D-II: Testing Requirements
- D-III: Monitoring Requirements
- D-IV: Recordkeeping Requirements
- D-V: Reporting Requirements
- D-VI: Work Practice Standards
- D-VII: Additional Requirements

Note: These same sub-sections are repeated for each source!

Section E. Source Group Restrictions

- E-I: Restrictions



SECTION A. Table of Contents

- E-II: Testing Requirements
- E-III: Monitoring Requirements
- E-IV: Recordkeeping Requirements
- E-V: Reporting Requirements
- E-VI: Work Practice Standards
- E-VII: Additional Requirements

Section F. Alternative Operating Scenario(s)

- F-I: Restrictions
- F-II: Testing Requirements
- F-III: Monitoring Requirements
- F-IV: Recordkeeping Requirements
- F-V: Reporting Requirements
- F-VI: Work Practice Standards
- F-VII: Additional Requirements

Section G. Emission Restriction Summary

Section H. Miscellaneous

**SECTION A. Site Inventory List**

Source ID	Source Name	Capacity/Throughput	Fuel/Material
102A	PAINT BOOTH & WASH PAD - DEPT. 264 NORTH EAST	12.000 Lbs/HR	VOC
108	PAINT BOOTH & WASH PAD- DEPT. 264 NORTH WEST	6.000 Lbs/HR	VOC
110	VACU-BLAST SHOT BLAST	20.000 Lbs/HR	SHOT CONSUMED
115	PAINT BOOTH SOLVENT USAGE	1.000 Lbs/HR	COATING SOLVENT USE
120	DEGREASING OPERATIONS	1.000 Gal/HR	SOLVENT
121	2 EMERGENCY GENERATORS (8 KW EACH)	0.060 MCF/HR	Natural Gas
122	EMERGENCY FIRE PUMP (248 HP)	0.630 MCF/HR	Natural Gas
125	PAINT BOOTH & WASH PAD-DEPT 244 FOOD AND BEVERAGE	4.670 MCF/HR	Natural Gas
		5.000 Lbs/HR	VOC
C102A	264 DRY FILTER SYSTEM		
C108	DRY FILTERS		
C110A	VACU-BLAST CYCLONE		
C110B	PANGBORN BAGHOUSE		
C125	DRY FILTERS		
FM001	NATURAL GAS SUPPLY		
S102A	102 BOOTH "A" STACK		
S102B	102 BOOTH "B" STACK		
S108A	108 BOOTH "A" STACK		
S108B	108 BOOTH "B" STACK		
S108C	108 BOOTH "C" STACK		
S108D	108 BOOTH "D" STACK		
S110	SHOT BLAST STACK		
S121	EMERGENCY GENERATOR STACK		
S122	EMERGENCY FIRE PUMP STACK		
S125A	PAINT BOOTH-DEPT 244 FOOD AND BEVERAGE "A" STACK		
S125B	F&B PAINT BOOTH "B" STACK		
Z115	PAINT BOOTH SOLVENT USAGE EMISSIONS		
Z120	DEGREASING EMISSIONS STACK		

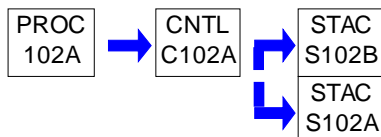
PERMIT MAPS



PERMIT MAPS

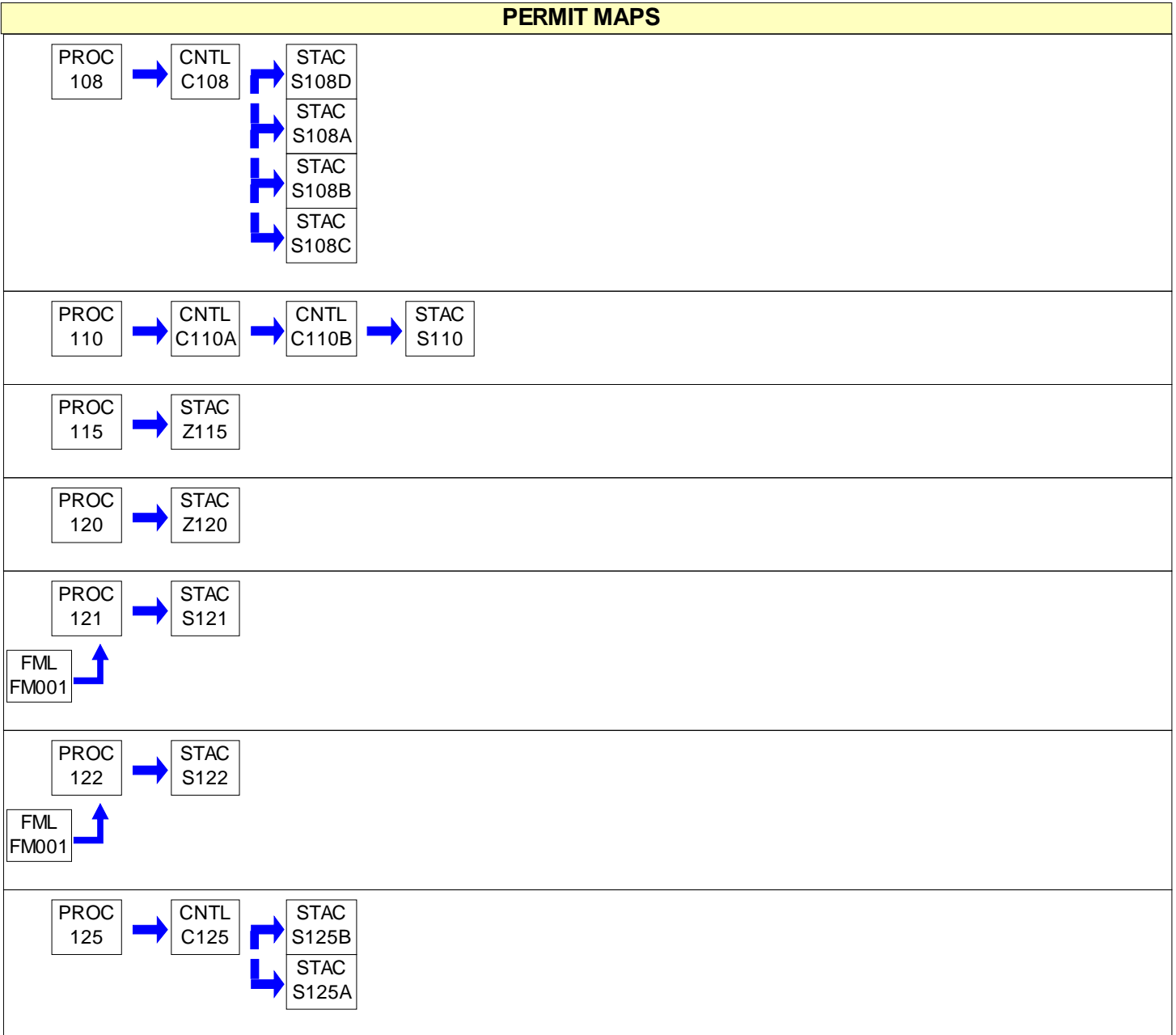

**SECTION B. General State Only Requirements****#001 [25 Pa. Code § 121.1]****Definitions.**

Words and terms that are not otherwise defined in this permit shall have the meanings set forth in Section 3 of the Air Pollution Control Act (35 P.S. § 4003) and in 25 Pa. Code § 121.1.

#002 [25 Pa. Code § 127.446]**Operating Permit Duration.**

(a) This operating permit is issued for a fixed term of five (5) years and shall expire on the date specified on Page 1 of this permit.

(b) The terms and conditions of the expired permit shall automatically continue pending issuance of a new operating permit, provided the permittee has submitted a timely and complete application and paid applicable fees required under 25 Pa. Code Chapter 127, Subchapter I and the Department is unable, through no fault of the permittee, to issue or deny a new permit before the expiration of the previous permit.

#003 [25 Pa. Code §§ 127.412, 127.413, 127.414, 127.446 & 127.703(b)]**Permit Renewal.**

(a) The permittee shall submit a timely and complete application for renewal of the operating permit to the appropriate Regional Air Program Manager. The application for renewal of the operating permit shall be submitted at least six (6) months and not more than 18 months before the expiration date of this permit.

(b) The application for permit renewal shall include the current permit number, a description of any permit revisions that occurred during the permit term, and any applicable requirements that were promulgated and not incorporated into the permit during the permit term. An application is complete if it contains sufficient information to begin processing the application, has the applicable sections completed and has been signed by a responsible official.

(c) The permittee shall submit with the renewal application a fee for the processing of the application as specified in 25 Pa. Code § 127.703(b). The fees shall be made payable to "The Commonwealth of Pennsylvania Clean Air Fund" and submitted with the fee form to the respective regional office.

(d) The renewal application shall also include submission of proof that the local municipality and county, in which the facility is located, have been notified in accordance with 25 Pa. Code § 127.413.

(e) The application for renewal of the operating permit shall also include submission of supplemental compliance review forms in accordance with the requirements of 25 Pa. Code § 127.412(b) and § 127.412(j).

(f) The permittee, upon becoming aware that any relevant facts were omitted or incorrect information was submitted in the permit application, shall promptly submit such supplementary facts or corrected information as necessary to address any requirements that become applicable to the source after the permittee submits a complete application, but prior to the date the Department takes action on the permit application.

#004 [25 Pa. Code § 127.703]**Operating Permit Fees under Subchapter I.**

(a) The permittee shall pay the annual operating permit maintenance fee according to the following fee schedule in either paragraph (1) or (2) in accordance with 25 Pa. Code § 127.703(d) on or before December 31 of each year for the next calendar year.

(1) For a synthetic minor facility, a fee equal to:

(i) Four thousand dollars (\$4,000) for calendar years 2021—2025.

(ii) Five thousand dollars (\$5,000) for calendar years 2026—2030.

(iii) Six thousand three hundred dollars (\$6,300) for the calendar years beginning with 2031.

**SECTION B. General State Only Requirements**

(2) For a facility that is not a synthetic minor, a fee equal to:

- (i) Two thousand dollars (\$2,000) for calendar years 2021—2025.
- (ii) Two thousand five hundred dollars (\$2,500) for calendar years 2026—2030.
- (iii) Three thousand one hundred dollars (\$3,100) for the calendar years beginning with 2031.

(b) The applicable fees shall be made payable to "The Commonwealth of Pennsylvania Clean Air Fund" with the permit number clearly indicated and submitted to the respective regional office.

#005 [25 Pa. Code §§ 127.450 (a)(4) and 127.464]**Transfer of Operating Permits.**

(a) This operating permit may not be transferred to another person, except in cases of transfer-of-ownership that are documented and approved by the Department.

(b) In accordance with 25 Pa. Code § 127.450(a)(4), a change in ownership of the source shall be treated as an administrative amendment if the Department determines that no other change in the permit is required and a written agreement has been submitted to the Department identifying the specific date of the transfer of permit responsibility, coverage and liability between the current and the new permittee and a compliance review form has been submitted to, and the permit transfer has been approved by, the Department.

(c) This operating permit is valid only for those specific sources and the specific source locations described in this permit.

#006 [25 Pa. Code § 127.441 and 35 P.S. § 4008]**Inspection and Entry.**

(a) Upon presentation of credentials and other documents as may be required by law, the permittee shall allow the Department or authorized representatives of the Department to perform the following:

(1) Enter at reasonable times upon the permittee's premises where a source is located or emissions related activity is conducted, or where records are kept under the conditions of this permit;

(2) Have access to and copy, at reasonable times, any records that are kept under the conditions of this permit;

(3) Inspect at reasonable times, any facilities, equipment including monitoring and air pollution control equipment, practices, or operations regulated or required under this permit;

(4) Sample or monitor, at reasonable times, any substances or parameters, for the purpose of assuring compliance with the permit or applicable requirements as authorized by the Clean Air Act, the Air Pollution Control Act, or the regulations promulgated under the Acts.

(b) Pursuant to 35 P.S. § 4008, no person shall hinder, obstruct, prevent or interfere with the Department or its personnel in the performance of any duty authorized under the Air Pollution Control Act or regulations adopted thereunder including denying the Department access to a source at this facility. Refusal of entry or access may constitute grounds for permit revocation and assessment of criminal and/or civil penalties.

(c) Nothing in this permit condition shall limit the ability of the EPA to inspect or enter the premises of the permittee in accordance with Section 114 or other applicable provisions of the Clean Air Act.

#007 [25 Pa. Code §§ 127.441 & 127.444]**Compliance Requirements.**

(a) The permittee shall comply with the conditions of this operating permit. Noncompliance with this permit constitutes a violation of the Clean Air Act and the Air Pollution Control Act and is grounds for one or more of the following:

**SECTION B. General State Only Requirements**

- (1) Enforcement action
- (2) Permit termination, revocation and reissuance or modification
- (3) Denial of a permit renewal application

(b) A person may not cause or permit the operation of a source which is subject to 25 Pa. Code Article III unless the source(s) and air cleaning devices identified in the application for the plan approval and operating permit and the plan approval issued for the source is operated and maintained in accordance with specifications in the applications and the conditions in the plan approval and operating permit issued by the Department. A person may not cause or permit the operation of an air contamination source subject to 25 Pa. Code Chapter 127 in a manner inconsistent with good operating practices.

(c) For purposes of Sub-condition (b) of this permit condition, the specifications in applications for plan approvals and operating permits are the physical configurations and engineering design details which the Department determines are essential for the permittee's compliance with the applicable requirements in this State-Only permit. Nothing in this sub-condition shall be construed to create an independent affirmative duty upon the permittee to obtain a predetermination from the Department for physical configuration or engineering design detail changes made by the permittee.

#008 [25 Pa. Code § 127.441]**Need to Halt or Reduce Activity Not a Defense.**

It shall not be a defense for the permittee in an enforcement action that it was necessary to halt or reduce the permitted activity in order to maintain compliance with the conditions of this permit.

#009 [25 Pa. Code §§ 127.442(a) & 127.461]**Duty to Provide Information.**

(a) The permittee shall submit reports to the Department containing information the Department may prescribe relative to the operation and maintenance of each source at the facility.

(b) The permittee shall furnish to the Department, in writing, information that the Department may request to determine whether cause exists for modifying, revoking and reissuing, or terminating this permit, or to determine compliance with the permit. Upon request, the permittee shall also furnish to the Department copies of records that the permittee is required to maintain in accordance with this permit.

#010 [25 Pa. Code § 127.461]**Revising an Operating Permit for Cause.**

This operating permit may be terminated, modified, suspended or revoked and reissued if one or more of the following applies:

- (1) The permittee constructs or operates the source subject to the operating permit so that it is in violation of the Air Pollution Control Act, the Clean Air Act, the regulations thereunder, a plan approval, a permit or in a manner that causes air pollution.
- (2) The permittee fails to properly or adequately maintain or repair an air pollution control device or equipment attached to or otherwise made a part of the source.
- (3) The permittee has failed to submit a report required by the operating permit or an applicable regulation.
- (4) The EPA determines that the permit is not in compliance with the Clean Air Act or the regulations thereunder.

#011 [25 Pa. Code §§ 127.450, 127.462, 127.465 & 127.703]**Operating Permit Modifications**

(a) The permittee is authorized to make administrative amendments, minor operating permit modifications and significant operating permit modifications, under this permit, as outlined below:

**SECTION B. General State Only Requirements**

(b) Administrative Amendments. The permittee shall submit the application for administrative operating permit amendments (as defined in 25 Pa. Code § 127.450(a)), according to procedures specified in § 127.450 unless precluded by the Clean Air Act or its regulations.

(c) Minor Operating Permit Modifications. The permittee shall submit the application for minor operating permit modifications (as defined 25 Pa. Code § 121.1) in accordance with 25 Pa. Code § 127.462.

(d) Significant Operating Permit Modifications. The permittee shall submit the application for significant operating permit modifications in accordance with 25 Pa. Code § 127.465.

(e) The applicable fees shall be made payable to "The Commonwealth of Pennsylvania Clean Air Fund" with the permit number clearly indicated and submitted to the respective regional office.

#012 [25 Pa. Code § 127.441]**Severability Clause.**

The provisions of this permit are severable, and if any provision of this permit is determined by a court of competent jurisdiction to be invalid or unenforceable, such a determination will not affect the remaining provisions of this permit.

#013 [25 Pa. Code § 127.449]**De Minimis Emission Increases.**

(a) This permit authorizes de minimis emission increases in accordance with 25 Pa. Code § 127.449 so long as the permittee provides the Department with seven (7) days prior written notice before commencing any de minimis emissions increase. The written notice shall:

(1) Identify and describe the pollutants that will be emitted as a result of the de minimis emissions increase.

(2) Provide emission rates expressed in tons per year and in terms necessary to establish compliance consistent with any applicable requirement.

(b) The Department may disapprove or condition de minimis emission increases at any time.

(c) Except as provided below in (d), the permittee is authorized to make de minimis emission increases (expressed in tons per year) up to the following amounts without the need for a plan approval or prior issuance of a permit modification:

(1) Four tons of carbon monoxide from a single source during the term of the permit and 20 tons of carbon monoxide at the facility during the term of the permit.

(2) One ton of NO_x from a single source during the term of the permit and 5 tons of NO_x at the facility during the term of the permit.

(3) One and six-tenths tons of the oxides of sulfur from a single source during the term of the permit and 8.0 tons of oxides of sulfur at the facility during the term of the permit.

(4) Six-tenths of a ton of PM₁₀ from a single source during the term of the permit and 3.0 tons of PM₁₀ at the facility during the term of the permit. This shall include emissions of a pollutant regulated under Section 112 of the Clean Air Act unless precluded by the Clean Air Act, the regulations thereunder or 25 Pa. Code Article III.

(5) One ton of VOCs from a single source during the term of the permit and 5.0 tons of VOCs at the facility during the term of the permit. This shall include emissions of a pollutant regulated under Section 112 of the Clean Air Act unless precluded by the Clean Air Act, the regulations thereunder or 25 Pa. Code Article III.

(6) Other sources and classes of sources determined to be of minor significance by the Department.

(d) In accordance with § 127.14, the permittee is authorized to install the following minor sources without the need for a plan approval or permit modification:

**SECTION B. General State Only Requirements**

- (1) Air conditioning or ventilation systems not designed to remove pollutants generated or released from other sources.
 - (2) Combustion units rated at 2,500,000 or less Btu per hour of heat input.
 - (3) Combustion units with a rated capacity of less than 10,000,000 Btu per hour heat input fueled by natural gas supplied by a public utility or by commercial fuel oils which are No. 2 or lighter, viscosity less than or equal to 5.82 c St, and which meet the sulfur content requirements of 25 Pa. Code §123.22 (relating to combustion units). For purposes of this permit, commercial fuel oil shall be virgin oil which has no reprocessed, recycled or waste material added.
 - (4) Space heaters which heat by direct heat transfer.
 - (5) Laboratory equipment used exclusively for chemical or physical analysis.
 - (6) Other sources and classes of sources determined to be of minor significance by the Department.
- (e) This permit does not authorize de minimis emission increases if the emissions increase would cause one or more of the following:
- (1) Increase the emissions of a pollutant regulated under Section 112 of the Clean Air Act except as authorized in Subparagraphs (c)(4) and (5) of this permit condition.
 - (2) Subject the facility to the prevention of significant deterioration requirements in 25 Pa. Code Chapter 127, Subchapter D and/or the new source review requirements in Subchapter E.
 - (3) Violate any applicable requirement of this permit, the Air Pollution Control Act, the Clean Air Act, or the regulations promulgated under either of the acts.
- (f) Emissions authorized under this permit condition shall be included in the monitoring, recordkeeping and reporting requirements of this permit.
- (g) Except for de minimis emission increases, installation of minor sources made pursuant to this permit condition and Plan Approval Exemptions under 25 Pa. Code § 127.14 (relating to exemptions), the permittee is prohibited from making changes or engaging in activities that are not specifically authorized under this permit without first applying for a plan approval. In accordance with § 127.14(b), a plan approval is not required for the construction, modification, reactivation, or installation of the sources creating the de minimis emissions increase.
- (h) The permittee may not meet de minimis emission threshold levels by offsetting emission increases or decreases at the same source.

#014 [25 Pa. Code § 127.3]**Operational Flexibility.**

The permittee is authorized to make changes within the facility in accordance with the regulatory provisions outlined in 25 Pa. Code § 127.3 (relating to operational flexibility) to implement the operational flexibility requirements provisions authorized under Section 6.1(i) of the Air Pollution Control Act and the operational flexibility terms and conditions of this permit. The provisions in 25 Pa. Code Chapter 127 which implement the operational flexibility requirements include the following:

- (1) Section 127.14 (relating to exemptions)
- (2) Section 127.447 (relating to alternative operating scenarios)
- (3) Section 127.448 (relating to emissions trading at facilities with Federally enforceable emissions caps)
- (4) Section 127.449 (relating to de minimis emission increases)
- (5) Section 127.450 (relating to administrative operating permit amendments)

**SECTION B. General State Only Requirements**

(6) Section 127.462 (relating to minor operating permit modifications)

(7) Subchapter H (relating to general plan approvals and general operating permits)

#015 [25 Pa. Code § 127.11]**Reactivation**

(a) The permittee may not reactivate a source that has been out of operation or production for at least one year unless the reactivation is conducted in accordance with a plan approval granted by the Department or in accordance with reactivation and maintenance plans developed and approved by the Department in accordance with 25 Pa. Code § 127.11a(a).

(b) A source which has been out of operation or production for more than five (5) years but less than 10 years may be reactivated and will not be considered a new source if the permittee satisfies the conditions specified in 25 Pa. Code § 127.11a(b).

#016 [25 Pa. Code § 127.36]**Health Risk-based Emission Standards and Operating Practice Requirements.**

(a) When needed to protect public health, welfare and the environment from emissions of hazardous air pollutants from new and existing sources, the permittee shall comply with the health risk-based emission standards or operating practice requirements imposed by the Department, except as precluded by §§ 6.6(d)(2) and (3) of the Air Pollution Control Act [35 P.S. § 4006.6(d)(2) and (3)].

(b) A person challenging a performance or emission standard established by the Department has the burden to demonstrate that performance or emission standard does not meet the requirements of Section 112 of the Clean Air Act.

#017 [25 Pa. Code § 121.9]**Circumvention.**

No person may permit the use of a device, stack height which exceeds good engineering practice stack height, dispersion technique or other technique which, without resulting in reduction of the total amount of air contaminants emitted, conceals or dilutes an emission of air contaminants which would otherwise be in violation of 25 Pa. Code Article III, except that with prior approval of the Department, the device or technique may be used for control of malodors.

#018 [25 Pa. Code §§ 127.402(d) & 127.442]**Reporting Requirements.**

(a) The permittee shall comply with the applicable reporting requirements of the Clean Air Act, the regulations thereunder, the Air Pollution Control Act and 25 Pa. Code Article III including Chapters 127, 135 and 139.

(b) The permittee shall submit reports to the Department containing information the Department may prescribe relative to the operation and maintenance of any air contamination source.

(c) Reports, test data, monitoring data, notifications and requests for renewal of the permit shall be submitted to the:

Regional Air Program Manager
PA Department of Environmental Protection
(At the address given in the permit transmittal letter, or otherwise notified)

(d) Any records or information including applications, forms, or reports submitted pursuant to this permit condition shall contain a certification by a responsible official as to truth, accuracy and completeness. The certifications submitted under this permit shall require a responsible official of the facility to certify that based on information and belief formed after reasonable inquiry, the statements and information in the documents are true, accurate and complete.

(e) Any records, reports or information submitted to the Department shall be available to the public except for such

**SECTION B. General State Only Requirements**

records, reports or information which meet the confidentiality requirements of § 4013.2 of the Air Pollution Control Act and §§ 112(d) and 114(c) of the Clean Air Act. The permittee may not request a claim of confidentiality for any emissions data generated for the facility.

#019 [25 Pa. Code §§ 127.441(c) & 135.5]**Sampling, Testing and Monitoring Procedures.**

(a) The permittee shall comply with the monitoring, recordkeeping or reporting requirements of 25 Pa. Code Chapter 139 and the other applicable requirements of 25 Pa. Code Article III and additional requirements related to monitoring, reporting and recordkeeping required by the Clean Air Act and the regulations thereunder including the Compliance Assurance Monitoring requirements of 40 CFR Part 64, where applicable.

(b) Unless alternative methodology is required by the Clean Air Act and regulations adopted thereunder, sampling, testing and monitoring required by or used by the permittee to demonstrate compliance with any applicable regulation or permit condition shall be conducted in accordance with the requirements of 25 Pa. Code Chapter 139.

#020 [25 Pa. Code §§ 127.441(c) and 135.5]**Recordkeeping.**

(a) The permittee shall maintain and make available, upon request by the Department, the following records of monitored information:

- (1) The date, place (as defined in the permit) and time of sampling or measurements.
- (2) The dates the analyses were performed.
- (3) The company or entity that performed the analyses.
- (4) The analytical techniques or methods used.
- (5) The results of the analyses.
- (6) The operating conditions as existing at the time of sampling or measurement.

(b) The permittee shall retain records of any required monitoring data and supporting information for at least five (5) years from the date of the monitoring, sample, measurement, report or application. Supporting information includes the calibration data and maintenance records and original strip-chart recordings for continuous monitoring instrumentation, and copies of reports required by the permit.

(c) The permittee shall maintain and make available to the Department upon request, records including computerized records that may be necessary to comply with the reporting, recordkeeping and emission statement requirements in 25 Pa. Code Chapter 135 (relating to reporting of sources). In accordance with 25 Pa. Code Chapter 135, § 135.5, such records may include records of production, fuel usage, maintenance of production or pollution control equipment or other information determined by the Department to be necessary for identification and quantification of potential and actual air contaminant emissions.

#021 [25 Pa. Code § 127.441(a)]**Property Rights.**

This permit does not convey any property rights of any sort, or any exclusive privileges.

#022 [25 Pa. Code § 127.447]**Alternative Operating Scenarios.**

The permittee is authorized to make changes at the facility to implement alternative operating scenarios identified in this permit in accordance with 25 Pa. Code § 127.447.

**SECTION B. General State Only Requirements****#023 [25 Pa. Code §135.3]****Reporting**

(a) If the facility is a Synthetic Minor Facility, the permittee shall submit by March 1 of each year an annual emissions report for the preceding calendar year. The report shall include information for all active previously reported sources, new sources which were first operated during the preceding calendar year, and sources modified during the same period which were not previously reported. All air emissions from the facility should be estimated and reported.

(b) A source owner or operator of a Synthetic Minor Facility may request an extension of time from the Department for the filing of an annual emissions report, and the Department may grant the extension for reasonable cause.

#024 [25 Pa. Code §135.4]**Report Format**

If applicable, the emissions reports shall contain sufficient information to enable the Department to complete its emission inventory. Emissions reports shall be made by the source owner or operator in a format specified by the Department.

**SECTION C. Site Level Requirements****I. RESTRICTIONS.****Emission Restriction(s).****# 001 [25 Pa. Code §123.1]****Prohibition of certain fugitive emissions**

The permittee may not allow the emission into the outdoor atmosphere of any fugitive air contaminant from a source other than the following:

- (1) Construction or demolition of buildings or structures.
- (2) Grading, paving and maintenance of roads and streets.
- (3) Use of roads and streets. Emissions from material in or on trucks, railroad cars and other vehicular equipment are not considered as emissions from use of roads and streets.
- (4) Clearing of land.
- (5) Stockpiling of materials.
- (6) Open burning operations.
- (7) Sources and classes of sources other than those identified above, for which the operator has obtained a determination from the Department that fugitive emissions from the source, after appropriate control, meet the following requirements:
 - (a) the emissions are of minor significance with respect to causing air pollution;
 - (b) the emissions are not preventing or interfering with the attainment or maintenance of any ambient air standard.

002 [25 Pa. Code §123.2]**Fugitive particulate matter**

The permittee may not allow fugitive particulate matter to be emitted into the outdoor atmosphere from a source specified in Section C, Condition #001, if the emissions are visible at the point the emissions pass outside the permittee's property.

003 [25 Pa. Code §123.31]**Limitations**

The permittee may not allow the emission into the outdoor atmosphere of any malodorous air contaminants from any source in such a manner that the malodors are detectable outside the permittee's property.

004 [25 Pa. Code §123.41]**Limitations**

The permittee may not allow the emission of visible air contaminants into the outdoor atmosphere in such a manner that the opacity of the emission is either of the following:

- (1) Equal to or greater than 20% for a period or periods aggregating more than three minutes in any one hour.
- (2) Equal to or greater than 60% at any time.

005 [25 Pa. Code §123.42]**Exceptions**

The emission limitations of Section C, Condition #004 (25 Pa Code section 123.41) shall not apply when:

- (1) The presence of uncombined water is the only reason for failure of the emission to meet the limitation.
- (2) The emission results from the operation of equipment used solely to train and test persons in observing the opacity of visible emissions;
- (3) The emission results from sources specified in Section C, Condition #001 subsections (1)-(7).

**SECTION C. Site Level Requirements****# 006 [25 Pa. Code §127.441]****Operating permit terms and conditions.**

In order to maintain the facility's Synthetic Minor status, the permittee shall limit the facility's actual emissions to below the following levels based on any consecutive 12-month period:

- (a) 100 tons/year of sulfur oxides
- (b) 100 tons/year of nitrogen oxides
- (c) 100 tons/year of carbon monoxide
- (d) 100 tons/year of PM-10 (particulate matter with an effective aerodynamic diameter of less than or equal to a nominal 10 micrometer body as measured by the applicable reference method or an equal method)
- (e) 100 tons/year of PM-2.5 (particulate matter with an aerodynamic diameter of less than or equal to a nominal 2.5 micrometer body as measured by the applicable reference method or an equivalent method)
- (f) 50 tons/year of volatile organic compounds
- (g) 10 tons/year of any individual hazardous air pollutant
- (h) 25 tons/year of total combined hazardous air pollutants

007 [25 Pa. Code §129.14]**Open burning operations**

(a) No person shall conduct the open burning of materials in such a manner that:

- (1) The emissions are visible, at any time, at the point such emissions pass outside the property of the person on whose land the open burning is being conducted.
- (2) Malodorous air contaminants from the open burning are detectable outside the property of the person on whose land the open burning is being conducted.
- (3) The emissions interfere with the reasonable enjoyment of life and property.
- (4) The emissions cause damage to vegetation or property.
- (5) The emissions are or may be deleterious to human or animal health.

(b) The requirements of Section (a), above, do not apply when the open burning operations result from:

- (1) A fire set to prevent or abate a fire hazard, when approved by the Department and set by or under the supervision of a public officer.
- (2) A fire set for the purpose of instructing personnel in fire fighting, when approved by the Department.
- (3) A fire set for the prevention and control of disease or pests, when approved by the Department.
- (4) A fire set solely for recreational or ceremonial purposes.
- (5) A fire set solely for cooking food.

(c) This permit does not constitute authorization to burn solid waste pursuant to Section 610 (3) of the Solid Waste Management Act, 35 P.S. Section 6018.610 (3), or any other provision of the Solid Waste Management Act.

**SECTION C. Site Level Requirements****II. TESTING REQUIREMENTS.****# 008 [25 Pa. Code §127.441]****Operating permit terms and conditions.**

The Department reserves the right to require exhaust stack testing of the sources and controls referenced in this permit to measure emissions for purposes including verification of permit condition compliance and estimation of annual air emissions.

009 [25 Pa. Code §139.1]**Sampling facilities.**

Upon the request of the Department, the permittee shall provide adequate sampling ports, safe sampling platforms and adequate utilities for the performance by the Department of tests on such sources. In the request, the Department will set forth the time period in which the facilities shall be provided as well as the specifications for such facilities.

010 [25 Pa. Code §139.11]**General requirements.**

(a) As specified in 25 Pa. Code Section 139.11(1), performance tests shall be conducted while the source is operating at maximum routine operating conditions or under such other conditions, within the capacity of the equipment, as may be requested by the Department.

(b) As specified in 25 Pa. Code Section 139.11(2), the Department will consider test results for approval where sufficient information is provided to verify the source conditions existing at the time of the test and where adequate data is available to show the manner in which the test was conducted. Information submitted to the Department shall include, at a minimum, all of the following:

- (1) A thorough source description, including a description of any air cleaning devices and the flue.
- (2) Process conditions, for example, the throughput rate of material, and other conditions which may affect emissions from the process.
- (3) The location of the sampling ports.
- (4) Effluent characteristics, including velocity, temperature, moisture content, gas density (percentage CO, CO₂, O₂, and N₂), static and barometric pressures.
- (5) Sample collection techniques employed, including procedures used, equipment descriptions, and data to verify that isokinetic sampling for particulate matter collection occurred and that acceptable test conditions were met.
- (6) Laboratory procedures and results.
- (7) Calculated results.

III. MONITORING REQUIREMENTS.**# 011 [25 Pa. Code §123.43]****Measuring techniques**

Visible emissions may be measured using either of the following:

- (1) A device approved by the Department and maintained to provide accurate opacity measurements.
- (2) Observers, trained and certified, to measure plume opacity with the naked eye, as per EPA Method 9, or with the aid of any devices approved by the Department.

012 [25 Pa. Code §127.441]**Operating permit terms and conditions.**

The permittee shall conduct a monthly inspection around the plant periphery during the daylight hours when the plant is in production to detect visible emissions, fugitive emissions and malodorous air contaminants. Monthly inspections are necessary to determine:

**SECTION C. Site Level Requirements**

- a) The presence of visible emissions. Visible emissions may be measured according to the methods specified in Section C, Condition #011. As an alternative, plant personnel who observe such visible emissions shall report each incident to the Department within four (4) hours of the occurrence and arrange for a certified observer to read the visible emissions.
- b) Presence of fugitive emissions beyond the facility property boundaries, as stated in Section C, Condition #002.
- c) Presence of odorous air contaminants beyond the facility property boundaries as stated in Section C, Condition #003.

IV. RECORDKEEPING REQUIREMENTS.**# 013 [25 Pa. Code §127.441]****Operating permit terms and conditions.**

The permittee shall maintain records of monthly inspections around the plant periphery. The records shall include, at minimum, the following information:

- 1.) The name of the company representative conducting the inspection.
- 2.) The date and time of the inspection.
- 3.) The wind direction.
- 4.) A description of any emissions and/or malodors observed and the actions taken to mitigate them. If none, record "NONE."

014 [25 Pa. Code §127.441]**Operating permit terms and conditions.**

Unless otherwise noted, all records required by this and subsequent operating permits shall be maintained for the most recent five-year period and shall be readily available to the Department upon request. The most recent two years of records must be retained at the facility. The remaining three years of records may be retained off site. The records may be retained on paper, microfilm, microfiche or computer disks. If the records are retained on computer disks, the records must be in commonly available software. Commonly available software is usually compatible with a Microsoft application such as Word or Excel.

015 [25 Pa. Code §127.441]**Operating permit terms and conditions.**

The permittee shall, monthly, unless another period is specified, record the quantities of all air contaminants listed in Section C, Condition #006. This list of contaminants shall be broken down on a source by source basis.

The permittee shall perform calculations each month and each consecutive 12-month period using AP-42 emission factors, material balance, manufacturer-supplied emission factors, stack test data, or other method(s) approved by the Department in order to demonstrate compliance with the emission limitations listed in Condition #006 of Section C. Additionally, the permittee shall keep appropriate records of all monitoring and testing requirements, if any. Monitoring requirements shall also be recorded monthly, unless otherwise specified.

The calculations and annual emission inventory report shall include:

- (a) The total consumption of all VOC and/or HAP containing coatings, thinners, cleanup solvents, and degreasers used at the facility.
- (b) The total emissions of each emergency engine and include the total operating hours of each engine.
- (c) Total emissions of Shotblast unit, Source ID 110.

V. REPORTING REQUIREMENTS.**# 016 [25 Pa. Code §127.442]****Reporting requirements.**

The permittee shall report malfunctions which occur at the facility to the Department. A malfunction is any sudden, infrequent, and not reasonably preventable failure of air pollution control equipment, process equipment, or a process to operate in a normal or usual manner that may result in an increase in air emissions above minor significance. Failures that are caused in part by poor maintenance or careless operation are not malfunctions. Malfunctions shall be reported as follows:

**SECTION C. Site Level Requirements**

(a) When the malfunction poses an imminent and substantial danger to the public health and safety or harm to the environment, the notification shall be submitted to the Department no later than two hours after the incident.

(1) The notice shall describe the:

- (i) name and location of the facility;
- (ii) nature and cause of the malfunction or breakdown;
- (iii) time when the malfunction or breakdown was first observed;
- (iv) expected duration of excess emissions; and
- (v) estimated rate of emissions.

(2) The owner or operator shall notify the Department immediately when corrective measures have been accomplished.

(3) The permittee shall submit a written report of instances of such malfunctions to the department, in writing, within three (3) days of discovery of the malfunction.

(4) The owner or operator shall submit reports on the operation and maintenance of the source to the Regional Air Program Manager at such intervals and in such form and detail as may be required by the Department. Information required in the reports may include, but is not limited to, process weight rates, firing rates, hours of operation, and maintenance schedules.

(b) Unless otherwise required by this permit, any other malfunction that is not subject to the reporting requirements of (a) above, shall be reported to the Department, in writing, within five (5) days of discovery of the malfunction.

(c) Unless otherwise approved by DEP, all malfunctions shall be reported through the Department's Greenport PUP system available through: <https://greenport.pa.gov/ePermitPublicAccess/PublicSubmission/Home>

Telephone reports can be made to the Air Quality Program at (814) 946-7290 during normal business hours or to the Department's Emergency Hotline. The Emergency Hotline phone number is changed/updated periodically. The current Emergency Hotline phone number can be found at <https://www.dep.pa.gov/About/Regional/SouthcentralRegion/Pages/default.aspx>.

017 [25 Pa. Code §135.3]**Reporting**

(a) An annual air emissions report for a given calendar year is due no later than March 1 of the following year, and shall be submitted through the Department's Greenport PUP system available through:

<https://greenport.pa.gov/ePermitPublicAccess/PublicSubmission/Home>

(b) The monthly air emissions and calculations referenced in Condition #015 of Section C shall be included in the annual air emissions report.

(c) The permittee may request an extension of time from the Department for the filing of the air emissions report specified in part (a), above, and the Department may grant the extension for reasonable cause.

VI. WORK PRACTICE REQUIREMENTS.**# 018 [25 Pa. Code §123.1]****Prohibition of certain fugitive emissions**

The permittee shall take all reasonable actions to prevent particulate matter from becoming airborne from any source specified in Section C, Condition #001(1)-(7). These actions shall include, but are not limited to the following:

(1) Use, where possible, of water or chemicals for control of dust in the demolition of buildings or structures, construction operations, the grading of roads, or the clearing of land.

(2) Application of asphalt, oil, water, or suitable chemicals on dirt roads, material stockpiles, and other surfaces which may give rise to airborne dusts.

**SECTION C. Site Level Requirements**

(3) Paving and maintenance of roadways.

(4) Prompt removal of earth or other material from paved streets onto which earth or other material has been transported by trucking or earth moving equipment, erosion by water, or other means.

019 [25 Pa. Code §127.441]

Operating permit terms and conditions.

Operation of any air emissions source is contingent upon proper operation of its associated emissions control system, unless otherwise approved by the Department.

020 [25 Pa. Code §127.444]

Compliance requirements.

The permittee shall operate and maintain all sources and air cleaning devices identified in this operating permit in accordance with the manufacturer's general recommendations and with good air pollution control practices.

VII. ADDITIONAL REQUIREMENTS.

No additional requirements exist except as provided in other sections of this permit including Section B (State Only General Requirements).

VIII. COMPLIANCE CERTIFICATION.

No additional compliance certifications exist except as provided in other sections of this permit including Section B (relating to State Only General Requirements).

IX. COMPLIANCE SCHEDULE.

No compliance milestones exist.

**SECTION D. Source Level Requirements**

Source ID: 102A

Source Name: PAINT BOOTH & WASH PAD - DEPT. 264 NORTH EAST

Source Capacity/Throughput: 12.000 Lbs/HR VOC

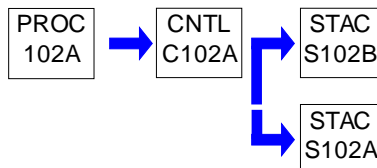
Conditions for this source occur in the following groups: 001
005**I. RESTRICTIONS.**

No additional requirements exist except as provided in other sections of this permit including Section B (State Only General Requirements) and/or Section E (Source Group Restrictions).

II. TESTING REQUIREMENTS.

No additional testing requirements exist except as provided in other sections of this permit including Section B (State Only General Requirements) and/or Section E (Source Group Restrictions).

III. MONITORING REQUIREMENTS.

No additional monitoring requirements exist except as provided in other sections of this permit including Section B (State Only General Requirements) and/or Section E (Source Group Restrictions).

IV. RECORDKEEPING REQUIREMENTS.

No additional record keeping requirements exist except as provided in other sections of this permit including Section B (State Only General Requirements) and/or Section E (Source Group Restrictions).

V. REPORTING REQUIREMENTS.

No additional reporting requirements exist except as provided in other sections of this permit including Section B (State Only General Requirements) and/or Section E (Source Group Restrictions).

VI. WORK PRACTICE REQUIREMENTS.

No additional work practice requirements exist except as provided in other sections of this permit including Section B (State Only General Requirements) and/or Section E (Source Group Restrictions).

VII. ADDITIONAL REQUIREMENTS.

No additional requirements exist except as provided in other sections of this permit including Section B (State Only General Requirements) and/or Section E (Source Group Restrictions).

**SECTION D. Source Level Requirements**

Source ID: 108

Source Name: PAINT BOOTH & WASH PAD- DEPT. 264 NORTH WEST

Source Capacity/Throughput: 6.000 Lbs/HR VOC

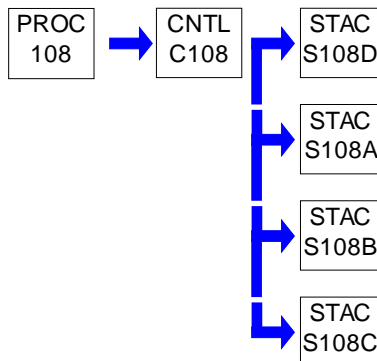
Conditions for this source occur in the following groups: 001
005**I. RESTRICTIONS.**

No additional requirements exist except as provided in other sections of this permit including Section B (State Only General Requirements) and/or Section E (Source Group Restrictions).

II. TESTING REQUIREMENTS.

No additional testing requirements exist except as provided in other sections of this permit including Section B (State Only General Requirements) and/or Section E (Source Group Restrictions).

III. MONITORING REQUIREMENTS.

No additional monitoring requirements exist except as provided in other sections of this permit including Section B (State Only General Requirements) and/or Section E (Source Group Restrictions).

IV. RECORDKEEPING REQUIREMENTS.

No additional record keeping requirements exist except as provided in other sections of this permit including Section B (State Only General Requirements) and/or Section E (Source Group Restrictions).

V. REPORTING REQUIREMENTS.

No additional reporting requirements exist except as provided in other sections of this permit including Section B (State Only General Requirements) and/or Section E (Source Group Restrictions).

VI. WORK PRACTICE REQUIREMENTS.

No additional work practice requirements exist except as provided in other sections of this permit including Section B (State Only General Requirements) and/or Section E (Source Group Restrictions).

VII. ADDITIONAL REQUIREMENTS.

No additional requirements exist except as provided in other sections of this permit including Section B (State Only General Requirements) and/or Section E (Source Group Restrictions).

**SECTION D. Source Level Requirements**

Source ID: 110

Source Name: VACU-BLAST SHOT BLAST

Source Capacity/Throughput:

20.000 Lbs/HR

SHOT CONSUMED

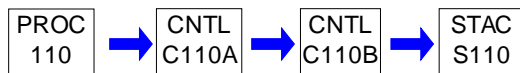
**I. RESTRICTIONS.****Emission Restriction(s).**

001 [25 Pa. Code §123.13]

Processes

No person shall permit the emission into the outdoor atmosphere of particulate matter from the shot blast unit in such a manner that the concentration of particulate matter in the effluent gas exceeds 0.04 grain per dry standard cubic foot.

II. TESTING REQUIREMENTS.

002 [25 Pa. Code §127.511]

Monitoring and related recordkeeping and reporting requirements.

The Department reserves the right to require exhaust stack testing of the shot blast unit as necessary during the permit term to verify emissions for purposes including emission fees, malfunctions or permit condition violations.

III. MONITORING REQUIREMENTS.

No additional monitoring requirements exist except as provided in other sections of this permit including Section B (State Only General Requirements).

IV. RECORDKEEPING REQUIREMENTS.

No additional record keeping requirements exist except as provided in other sections of this permit including Section B (State Only General Requirements).

V. REPORTING REQUIREMENTS.

No additional reporting requirements exist except as provided in other sections of this permit including Section B (State Only General Requirements).

VI. WORK PRACTICE REQUIREMENTS.

No additional work practice requirements exist except as provided in other sections of this permit including Section B (State Only General Requirements).

VII. ADDITIONAL REQUIREMENTS.

No additional requirements exist except as provided in other sections of this permit including Section B (State Only General Requirements).

**SECTION D. Source Level Requirements**

Source ID: 115

Source Name: PAINT BOOTH SOLVENT USAGE

Source Capacity/Throughput:

1.000 Lbs/HR

COATING SOLVENT USE

Conditions for this source occur in the following groups: 001
005

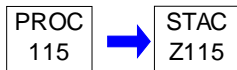
**I. RESTRICTIONS.**

No additional requirements exist except as provided in other sections of this permit including Section B (State Only General Requirements) and/or Section E (Source Group Restrictions).

II. TESTING REQUIREMENTS.

No additional testing requirements exist except as provided in other sections of this permit including Section B (State Only General Requirements) and/or Section E (Source Group Restrictions).

III. MONITORING REQUIREMENTS.**# 001 [25 Pa. Code §127.441]****Operating permit terms and conditions.**

(a) The permittee shall maintain the following records for the Source ID 115 cleanup solvents:

- (1) Monthly usage of each VOC- and/or HAP-containing material
- (2) Monthly quantity of waste material sent off-site for recycling or disposal*
- (3) Waste profile or sampling data for each shipment*
- (4) Identification of the waste disposal company for each shipment, including waste disposal manifest*
- (5) Resultant monthly and 12-month rolling VOC and HAP(s) emissions

* only required if the permittee wishes to obtain credit for VOC and/or HAP(s) emissions

(b) These records shall be maintained for a minimum of five (5) years and shall be made available to the Department upon its request.

(c) The permittee shall include the information in part (a), above, in the annual air emissions report referenced in Section C, Condition #015.

IV. RECORDKEEPING REQUIREMENTS.

No additional record keeping requirements exist except as provided in other sections of this permit including Section B (State Only General Requirements) and/or Section E (Source Group Restrictions).

V. REPORTING REQUIREMENTS.

No additional reporting requirements exist except as provided in other sections of this permit including Section B (State Only General Requirements) and/or Section E (Source Group Restrictions).

**SECTION D. Source Level Requirements****VI. WORK PRACTICE REQUIREMENTS.**

No additional work practice requirements exist except as provided in other sections of this permit including Section B (State Only General Requirements) and/or Section E (Source Group Restrictions).

VII. ADDITIONAL REQUIREMENTS.

No additional requirements exist except as provided in other sections of this permit including Section B (State Only General Requirements) and/or Section E (Source Group Restrictions).

**SECTION D. Source Level Requirements**

Source ID: 120

Source Name: DEGREASING OPERATIONS

Source Capacity/Throughput:

1.000 Gal/HR

SOLVENT

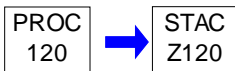
**I. RESTRICTIONS.****Emission Restriction(s).****# 001 [25 Pa. Code §129.63]****Degreasing operations**

Degreasing activities shall be conducted in accordance with the applicable requirements of 25 Pa. Code Section 129.63 to include the following:

(a) After December 22, 2002, Source ID 120 units shall not employ any solvent with a vapor pressure of 1.0 millimeter of mercury (mm Hg) or greater and containing greater than 5% VOC by weight, measured at 20°C (68°F) containing VOCs.

(b) This permit condition does not apply when:

(1) Source ID 120 units are used in extreme cleaning service. Extreme cleaning service is defined as the use of a cold cleaning machine to clean parts used in the manufacture of the following gases or to clean parts exposed to these gases in manufacturing, production, research and development, analytical work, or other similar operations:

- (A) Oxygen in concentrations greater than 23%
- (B) Ozone
- (C) Nitrous oxide
- (D) Fluorine
- (E) Chlorine
- (F) Bromine
- (G) Halogenated compounds

(2) The permittee demonstrates, and the Department approves in writing, that compliance with this permit condition will result in unsafe operating conditions.

II. TESTING REQUIREMENTS.

No additional testing requirements exist except as provided in other sections of this permit including Section B (State Only General Requirements).

III. MONITORING REQUIREMENTS.

No additional monitoring requirements exist except as provided in other sections of this permit including Section B (State Only General Requirements).

IV. RECORDKEEPING REQUIREMENTS.**# 002 [25 Pa. Code §129.63]****Degreasing operations**

The permittee shall maintain the following records on and after December 22, 2002:

- (a) The name and address of the solvent supplier.
- (b) The type of solvent including the product or vendor identification number.
- (c) The vapor pressure of the solvent measured in mm Hg at 20°C (68°F).

**SECTION D. Source Level Requirements**

An invoice, bill of sale, or certificate that corresponds to a number of sales, Material Safety Data Sheet (MSDS), or other appropriate documentation acceptable to the Department may be used to comply with this section.

The permittee shall retain these records for a minimum of five (5) years and shall make them available to the Department upon its request.

V. REPORTING REQUIREMENTS.**# 003 [25 Pa. Code §127.444]****Compliance requirements.**

(a) The permittee shall maintain the following records for the Source ID 120 Degreasing Operations:

- (1) Monthly usage of each VOC- and/or HAP-containing material
- (2) Monthly quantity of waste material sent off-site for recycling or disposal*
- (3) Waste profile or sampling data for each shipment*
- (4) Identification of the waste disposal company for each shipment, including waste disposal manifest*
- (5) Resultant monthly and 12-month rolling VOC and HAP(s) emissions

* only required if the permittee wishes to obtain credit for VOC and/or HAP(s) emissions

(b) These records shall be maintained for a minimum of five (5) years and shall be made available to the Department upon its request.

(c) The permittee shall include the information in part (a), above, in the annual air emissions report referenced in Section C, Condition #012(a).

VI. WORK PRACTICE REQUIREMENTS.**# 004 [25 Pa. Code §129.63]****Degreasing operations**

Each Source ID 120 unit shall be equipped with one of the following:

- (a) A cover that shall be closed at all times except during cleaning of parts or the addition or removal of solvent.
- (b) A perforated drain with a diameter of not more than six (6) inches, if the unit drains directly into the solvent storage reservoir.

005 [25 Pa. Code §129.63]**Degreasing operations**

The permittee shall operate each Source ID 120 unit in accordance with the following procedures:

- (a) Waste solvent shall be collected and stored in closed containers. The closed containers may contain a device that allows pressure relief, but does not allow liquid solvent to drain from the container.
- (b) Flushing of parts using a flexible hose or other flushing device shall be performed only within the unit. The solvent spray shall be a solid fluid stream, not an atomized or shower spray.
- (c) Sponges, fabric, wood, leather, paper products and other absorbent materials may not be cleaned in Source ID 101 units.
- (d) Air-agitated solvent baths may not be used.
- (e) Spills during solvent transfer and use of each Source ID 101 unit shall be cleaned up immediately.

006 [25 Pa. Code §129.63]**Degreasing operations**

Each Source ID 120 unit shall have a permanent, conspicuous label summarizing the operating requirements in Condition #004. In addition, the label shall include the following discretionary good operating practices:

**SECTION D. Source Level Requirements**

- (a) Cleaned parts should be drained at least 15 seconds or until dripping ceases, whichever is longer. Parts having cavities or blind holes shall be tipped or rotated while the part is draining. During the draining, tipping or rotating, the parts should be positioned so that solvent drains directly back to the unit.
- (b) When a pump-agitated solvent bath is used, the agitator should be operated to produce a rolling motion of the solvent with no observable splashing of the solvent against the tank walls or the parts being cleaned.
- (c) Work area fans should be located and positioned so that they do not blow across the opening of the degreaser unit.

VII. ADDITIONAL REQUIREMENTS.**# 007 [25 Pa. Code §129.63]****Degreasing operations**

All of the aforementioned permit conditions apply to each Source ID 120 unit so long as the cold cleaning machine uses 2 gallons or more of solvents containing greater than 5% VOC content by weight for the cleaning of metal parts.

**SECTION D. Source Level Requirements**

Source ID: 121

Source Name: 2 EMERGENCY GENERATORS (8 KW EACH)

Source Capacity/Throughput:

0.060 MCF/HR

Natural Gas

Conditions for this source occur in the following groups: 004

**I. RESTRICTIONS.****Emission Restriction(s).****# 001 [25 Pa. Code §123.13]****Processes**

The permittee shall not allow the emission into the outdoor atmosphere of particulate matter (PM) from the Source ID 121 engines in a manner that the concentration of PM in the effluent gas exceeds 0.04 grain per dry standard cubic foot.

002 [25 Pa. Code §123.21]**General**

The permittee shall not allow the emission into the outdoor atmosphere of sulfur oxides from the Source ID 121 engines in a manner that the concentration of the sulfur oxides (expressed as SO₂) in the effluent gas exceeds 500 parts per million, by volume, dry basis.

Operation Hours Restriction(s).**# 003 [25 Pa. Code §127.444]****Compliance requirements.**

The Source ID 121 engines shall not operate more than 500 hours each during any consecutive 12-month period.

II. TESTING REQUIREMENTS.

No additional testing requirements exist except as provided in other sections of this permit including Section B (State Only General Requirements) and/or Section E (Source Group Restrictions).

III. MONITORING REQUIREMENTS.

No additional monitoring requirements exist except as provided in other sections of this permit including Section B (State Only General Requirements) and/or Section E (Source Group Restrictions).

IV. RECORDKEEPING REQUIREMENTS.

No additional record keeping requirements exist except as provided in other sections of this permit including Section B (State Only General Requirements) and/or Section E (Source Group Restrictions).

V. REPORTING REQUIREMENTS.**# 004 [25 Pa. Code §127.444]****Compliance requirements.**

(a) The permittee shall maintain records of the Source ID 121 engines' monthly hours of operation.

(b) The permittee shall maintain records of the Source ID 121 engines' cumulative hours of operation for each consecutive

**SECTION D. Source Level Requirements**

12-month period. This is necessary to demonstrate compliance with Condition #004, above.

(c) The permittee shall retain these records for a minimum of five (5) years. The records shall be made available to the Department upon its request.

VI. WORK PRACTICE REQUIREMENTS.

No additional work practice requirements exist except as provided in other sections of this permit including Section B (State Only General Requirements) and/or Section E (Source Group Restrictions).

VII. ADDITIONAL REQUIREMENTS.

No additional requirements exist except as provided in other sections of this permit including Section B (State Only General Requirements) and/or Section E (Source Group Restrictions).

**SECTION D. Source Level Requirements**

Source ID: 122

Source Name: EMERGENCY FIRE PUMP (248 HP)

Source Capacity/Throughput:

0.630 MCF/HR

Natural Gas

Conditions for this source occur in the following groups: 004

**I. RESTRICTIONS.****Emission Restriction(s).**

001 [25 Pa. Code §123.13]

Processes

The permittee shall not allow the emission into the outdoor atmosphere of particulate matter (PM) from the Source ID 122 engine in a manner that the concentration of PM in the effluent gas exceeds 0.04 grain per dry standard cubic foot.

002 [25 Pa. Code §123.21]

General

The permittee shall not allow the emission into the outdoor atmosphere of sulfur oxides from the Source ID 122 engine in a manner that the concentration of the sulfur oxides (expressed as SO₂) in the effluent gas exceeds 500 parts per million, by volume, dry basis.

Operation Hours Restriction(s).

003 [25 Pa. Code §127.444]

Compliance requirements.

The Source ID 122 engine shall not operate more than 500 hours during any consecutive 12-month period.

II. TESTING REQUIREMENTS.

No additional testing requirements exist except as provided in other sections of this permit including Section B (State Only General Requirements) and/or Section E (Source Group Restrictions).

III. MONITORING REQUIREMENTS.

No additional monitoring requirements exist except as provided in other sections of this permit including Section B (State Only General Requirements) and/or Section E (Source Group Restrictions).

IV. RECORDKEEPING REQUIREMENTS.

004 [25 Pa. Code §127.444]

Compliance requirements.

- The permittee shall maintain records of the Source ID 122 engine's monthly hours of operation.
- The permittee shall maintain records of the Source ID 122 engine's cumulative hours of operation for each consecutive 12-month period. This is necessary to demonstrate compliance with Condition #004, above.
- The permittee shall retain these records for a minimum of five (5) years. The records shall be made available to the Department upon its request.

**SECTION D. Source Level Requirements****V. REPORTING REQUIREMENTS.**

No additional reporting requirements exist except as provided in other sections of this permit including Section B (State Only General Requirements) and/or Section E (Source Group Restrictions).

VI. WORK PRACTICE REQUIREMENTS.

No additional work practice requirements exist except as provided in other sections of this permit including Section B (State Only General Requirements) and/or Section E (Source Group Restrictions).

VII. ADDITIONAL REQUIREMENTS.

No additional requirements exist except as provided in other sections of this permit including Section B (State Only General Requirements) and/or Section E (Source Group Restrictions).

**SECTION D. Source Level Requirements**

Source ID: 125

Source Name: PAINT BOOTH & WASH PAD-DEPT 244 FOOD AND BEVERAGE

Source Capacity/Throughput:	4.670 MCF/HR	Natural Gas
	5.000 Lbs/HR	VOC

Conditions for this source occur in the following groups: 001
005

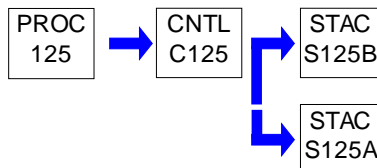
**I. RESTRICTIONS.****Emission Restriction(s).****# 001 [25 Pa. Code §127.441]****Operating permit terms and conditions.**

Pursuant to the Best Available Technology provisions of §§127.1 and 127.12, total VOC emissions from the Source ID 125 paint booth shall not exceed 15.0 tons for any consecutive 12-month period.

[Additional authority for this permit condition was derived from PA 28-05047A]

II. TESTING REQUIREMENTS.

No additional testing requirements exist except as provided in other sections of this permit including Section B (State Only General Requirements) and/or Section E (Source Group Restrictions).

III. MONITORING REQUIREMENTS.

No additional monitoring requirements exist except as provided in other sections of this permit including Section B (State Only General Requirements) and/or Section E (Source Group Restrictions).

IV. RECORDKEEPING REQUIREMENTS.**# 002 [25 Pa. Code §127.441]****Operating permit terms and conditions.**

Pursuant to the Best Available Technology (BAT) provisions of 25 PA Code §§ 127.1 and 127.12, the permittee shall verify compliance with the annual VOC emission limits in Condition #001 by calculating the VOC emissions from the Source ID 125 paint booth for each calendar month and each consecutive 12-month period.

[Additional authority for this permit condition was derived from PA 67-05047A]

V. REPORTING REQUIREMENTS.

No additional reporting requirements exist except as provided in other sections of this permit including Section B (State Only General Requirements) and/or Section E (Source Group Restrictions).

VI. WORK PRACTICE REQUIREMENTS.

No additional work practice requirements exist except as provided in other sections of this permit including Section B (State Only General Requirements) and/or Section E (Source Group Restrictions).

**SECTION D. Source Level Requirements****VII. ADDITIONAL REQUIREMENTS.**

No additional requirements exist except as provided in other sections of this permit including Section B (State Only General Requirements) and/or Section E (Source Group Restrictions).

**SECTION E. Source Group Restrictions.**

Group Name: 001

Group Description: paint booths

Sources included in this group

ID	Name
102A	PAINT BOOTH & WASH PAD - DEPT. 264 NORTH EAST
108	PAINT BOOTH & WASH PAD- DEPT. 264 NORTH WEST
115	PAINT BOOTH SOLVENT USAGE
125	PAINT BOOTH & WASH PAD-DEPT 244 FOOD AND BEVERAGE

I. RESTRICTIONS.**Emission Restriction(s).****# 001 [25 Pa. Code §127.441]****Operating permit terms and conditions.**

(1) The permittee shall not allow the emission into the outdoor atmosphere of particulate matter from any Group 001 Source except Source ID 125 paint booth in a manner that the concentration of particulate matter in the effluent gas exceeds .04 grains per dry standard cubic foot.

(2) Pursuant to the Best Available Technology provisions of §§127.1 and 127.12, the permittee shall not allow the emission into the outdoor atmosphere of particulate matter from the Source ID 125 paint booth in a manner that the concentration of particulate matter in the effluent gas exceeds .02 grains per dry standard cubic foot.

II. TESTING REQUIREMENTS.**# 002 [25 Pa. Code §127.441]****Operating permit terms and conditions.**

Sampling and testing of the coatings shall be done in accordance with the procedures and test methods specified in Chapter 139 (relating to sampling and testing).

III. MONITORING REQUIREMENTS.**# 003 [25 Pa. Code §127.441]****Operating permit terms and conditions.**

The permittee shall weekly, inspect the paint booth filters and monitor pressure drop readings across the filters on the Group 001 sources to assure proper operation in accordance with the manufacturer's requirements. The permittee shall keep records of the weekly pressure drop readings and paint booth filter inspections as well as any paint booth filter replacements for the most recent 5-year period and made available to the Department upon request.

004 [25 Pa. Code §129.52]**Surface coating processes**

The permittee shall demonstrate the VOC/HAP content of each surface coating by one of the following methods:

(a) For surface coatings applied as they are received from the manufacturer, the permittee may demonstrate compliance with the applicable standard by obtaining EPA Method 24 certification testing from the manufacturer, or by maintaining VOC/HAP data sheets from the manufacturer.

(b) In the absence of EPA Method 24 certification testing from the manufacturer, or VOC/HAP data sheets from the manufacturer, allowed under part (a), above, the permittee shall perform EPA Method 24 certification testing on all surface coatings applied as received from the manufacturer.

(c) The permittee may use calculated VOC content values in lieu of EPA Method 24 certification testing for multi-part surface coatings where the permittee maintains VOC/HAP data sheets for all surface coating constituents (i.e. coatings, pigments, thinners/cutting solvents), and also maintains documentation from the manufacturer as to the recommended mix ratio of the parts. In the event of any inconsistency between the calculated VOC content and data obtained from EPA Method 24 certification testing, the latter shall take precedence.

**SECTION E. Source Group Restrictions.****IV. RECORDKEEPING REQUIREMENTS.****# 005 [25 Pa. Code §129.52]****Surface coating processes**

The company shall maintain detailed records which shall include as a minimum the following:

(a) The facility shall maintain daily records of:

1. The coating, thinner or component name and identification number.
2. The volume used.
3. The mix ratio.
4. The density or specific gravity.
5. The weight percent of total volatiles, water, solids and exempt solvents.
6. Volume percent of solids

(b) The VOC/HAP content of each coating, thinner and other component as supplied.

(c) The VOC/HAP content of each as applied coating.

(d) All records shall be maintained for 5 years and shall be made available to the Department upon request.

V. REPORTING REQUIREMENTS.**# 006 [25 Pa. Code §129.52]****Surface coating processes**

Annual reports containing, but not limited to, the following data for each coating shall be submitted to the Air Quality District Supervisor.

- (a) Coating identification
- (b) Coating use (e.g., extreme performance coating)
- (c) Pounds of VOC per gallon coating solids
- (d) Weight percent of VOC (Wv-Ww-Wex)
- (e) Weight percent of total volatiles (100% - weight percent solids)
- (f) Weight percent of water
- (g) Weight percent of exempt solvents
- (h) Density of coating, lb/gal, at 25°C
- (i) Volume percent of solids of the as applied coating
- (j) Gallons per year of coating used
- (k) Pounds per year of VOC and HAP emissions
- (l) Type and amount of regulated cleanup solvents used

The permittee shall include the information above, in the annual air emissions report referenced in Section C, Condition #017.

007 [25 Pa. Code §129.52]**Surface coating processes**

The permittee shall provide the following information for waste coatings, solvents, or mixtures sent off-site for recycling or disposal in order to obtain credit for VOC and HAP(s) emissions reporting for Condition #006:

- (1) Pounds or gallons per month of waste coatings, solvents, or mixtures shipped from the facility,
- (2) Waste profile or sampling data for each shipment,
- (3) Identification of the waste disposal company for each shipment.

VI. WORK PRACTICE REQUIREMENTS.

No additional work practice requirements exist except as provided in other sections of this permit including Section B (State Only General Requirements).

**SECTION E. Source Group Restrictions.****VII. ADDITIONAL REQUIREMENTS.**

No additional requirements exist except as provided in other sections of this permit including Section B (State Only General Requirements).

**SECTION E. Source Group Restrictions.**

Group Name: 004

Group Description: 40 CFR Part 63, Subpart ZZZZ Requirements

Sources included in this group

ID	Name
121	2 EMERGENCY GENERATORS (8 KW EACH)
122	EMERGENCY FIRE PUMP (248 HP)

I. RESTRICTIONS.

No additional requirements exist except as provided in other sections of this permit including Section B (State Only General Requirements).

II. TESTING REQUIREMENTS.

No additional testing requirements exist except as provided in other sections of this permit including Section B (State Only General Requirements).

III. MONITORING REQUIREMENTS.

No additional monitoring requirements exist except as provided in other sections of this permit including Section B (State Only General Requirements).

IV. RECORDKEEPING REQUIREMENTS.

No additional record keeping requirements exist except as provided in other sections of this permit including Section B (State Only General Requirements).

V. REPORTING REQUIREMENTS.

No additional reporting requirements exist except as provided in other sections of this permit including Section B (State Only General Requirements).

VI. WORK PRACTICE REQUIREMENTS.

No additional work practice requirements exist except as provided in other sections of this permit including Section B (State Only General Requirements).

VII. ADDITIONAL REQUIREMENTS.**# 001 [40 CFR Part 63 NESHAPS for Source Categories §40 CFR 63.6585]****Subpart ZZZZ - National Emissions Standards for Hazardous Air Pollutants for Stationary Reciprocating Internal Combustion Engines****Am I subject to this subpart?**

§ 63.6585 Am I subject to this subpart?

You are subject to this subpart if you own or operate a stationary RICE at a major or area source of HAP emissions, except if the stationary RICE is being tested at a stationary RICE test cell/stand.

(a) A stationary RICE is any internal combustion engine which uses reciprocating motion to convert heat energy into mechanical work and which is not mobile. Stationary RICE differ from mobile RICE in that a stationary RICE is not a non-road engine as defined at 40 CFR 1068.30, and is not used to propel a motor vehicle or a vehicle used solely for competition.

(b) A major source of HAP emissions is a plant site that emits or has the potential to emit any single HAP at a rate of 10 tons (9.07 megagrams) or more per year or any combination of HAP at a rate of 25 tons (22.68 megagrams) or more per year, except that for oil and gas production facilities, a major source of HAP emissions is determined for each surface site.

(c) An area source of HAP emissions is a source that is not a major source.

(d) If you are an owner or operator of an area source subject to this subpart, your status as an entity subject to a standard or

**SECTION E. Source Group Restrictions.**

other requirements under this subpart does not subject you to the obligation to obtain a permit under 40 CFR part 70 or 71, provided you are not required to obtain a permit under 40 CFR 70.3(a) or 40 CFR 71.3(a) for a reason other than your status as an area source under this subpart. Notwithstanding the previous sentence, you must continue to comply with the provisions of this subpart as applicable.

(e) [NA – NOT USED FOR NATIONAL SECURITY PURPOSES]

(f) [NA – RICE NOT RESIDENTIAL, COMMERCIAL OR INSTITUTIONAL]

[69 FR 33506, June 15, 2004, as amended at 73 FR 3603, Jan. 18, 2008; 78 FR 6700, Jan. 30, 2013; 87 FR 48607, Aug. 10, 2022]

§ 63.6590 What parts of my plant does this subpart cover?

This subpart applies to each affected source.

(a) Affected source. An affected source is any existing, new, or reconstructed stationary RICE located at a major or area source of HAP emissions, excluding stationary RICE being tested at a stationary RICE test cell/stand.

(1) Existing stationary RICE.

(i) [NA – NOT A MAJOR HAP SOURCE]

(ii) [NA – NOT A MAJOR HAP SOURCE]

(iii) For stationary RICE located at an area source of HAP emissions, a stationary RICE is existing if you commenced construction or reconstruction of the stationary RICE before June 12, 2006.

(iv) A change in ownership of an existing stationary RICE does not make that stationary RICE a new or reconstructed stationary RICE.

(2) New stationary RICE. (i) [NA – NOT A MAJOR HAP SOURCE]

(ii) [NA – NOT A MAJOR HAP SOURCE]

(iii) [NA – NOT A NEW SOURCE]

(3) [NA – NOT A RECONSTRUCTED SOURCE]

(b) Stationary RICE subject to limited requirements. (1) An affected source which meets either of the criteria in paragraphs (b)(1)(i) through (ii) of this section does not have to meet the requirements of this subpart and of subpart A of this part except for the initial notification requirements of § 63.6645(f).

(i) [NA – NOT A MAJOR HAP SOURCE]

(ii) [NA – NOT A MAJOR HAP SOURCE]

(2) [NA – NOT A MAJOR HAP SOURCE AND DOES NOT COMBUST LFG]

(3) The following stationary RICE do not have to meet the requirements of this subpart and of subpart A of this part, including initial notification requirements:

(i) [NA – NOT A MAJOR HAP SOURCE]

(ii) [NA – NOT A MAJOR HAP SOURCE]

(iii) [NA – NOT A MAJOR HAP SOURCE]

**SECTION E. Source Group Restrictions.**

(iv) [NA – NOT A MAJOR HAP SOURCE]

(v) [NA – NOT A MAJOR HAP SOURCE AND DOES NOT COMBUST LFG]

(c) [NA – NOT SUBJECT TO SUBPARTS IIII OR JJJJ]

[69 FR 33506, June 15, 2004, as amended at 73 FR 3604, Jan. 18, 2008; 75 FR 9674, Mar. 3, 2010; 75 FR 37733, June 30, 2010; 75 FR 51588, Aug. 20, 2010; 78 FR 6700, Jan. 30, 2013; 87 FR 48607, Aug. 10, 2022]

§ 63.6595 When do I have to comply with this subpart?

(a) Affected sources. (1) If you have an existing stationary RICE, excluding existing non-emergency CI stationary RICE, with a site rating of more than 500 brake HP located at a major source of HAP emissions, you must comply with the applicable emission limitations, operating limitations and other requirements no later than June 15, 2007. IF YOU HAVE an existing non-emergency CI stationary RICE with a site rating of more than 500 brake HP located at a major source of HAP emissions, an existing stationary CI RICE with a site rating of less than or equal to 500 brake HP located at a major source of HAP emissions, or AN EXISTING STATIONARY CI RICE LOCATED AT AN AREA SOURCE OF HAP EMISSIONS, YOU MUST COMPLY WITH THE APPLICABLE EMISSION LIMITATIONS, OPERATING LIMITATIONS, AND OTHER REQUIREMENTS NO LATER THAN MAY 3, 2013.

IF YOU HAVE an existing stationary SI RICE with a site rating of less than or equal to 500 brake HP located at a major source of hap emissions, or AN EXISTING STATIONARY SI RICE LOCATED AT AN AREA SOURCE OF HAP EMISSIONS, YOU MUST COMPLY WITH THE APPLICABLE EMISSION LIMITATIONS, OPERATING LIMITATIONS, AND OTHER REQUIREMENTS NO LATER THAN OCTOBER 19, 2013.

(2) [NA – NOT A MAJOR HAP SOURCE]

(3) [NA – NOT A MAJOR HAP SOURCE]

(4) [NA – NOT A MAJOR HAP SOURCE]

(5) [NA – NOT A MAJOR HAP SOURCE]

(6) [NA – NOT SUBJECT TO EMISSION OR OPERATING LIMITATIONS]

(7) [NA – NOT SUBJECT TO EMISSION OR OPERATING LIMITATIONS]

(b) Area sources that become major sources. If you have an area source that increases its emissions or its potential to emit such that it becomes a major source of HAP, the compliance dates in paragraphs (b)(1) and (2) of this section apply to you.

(1) Any stationary RICE for which construction or reconstruction is commenced after the date when your area source becomes a major source of HAP must be in compliance with this subpart upon startup of your affected source.

(2) Any stationary RICE for which construction or reconstruction is commenced before your area source becomes a major source of HAP must be in compliance with the provisions of this subpart that are applicable to RICE located at major sources within 3 years after your area source becomes a major source of HAP.

(c) If you own or operate an affected source, you must meet the applicable notification requirements in § 63.6645 and in 40 CFR part 63, subpart A.

[69 FR 33506, June 15, 2004, as amended at 73 FR 3604, Jan. 18, 2008; 75 FR 9675, Mar. 3, 2010; 75 FR 51589, Aug. 20, 2010; 78 FR 6701, Jan. 30, 2013]

Emission and Operating Limitations

§ 63.6600 What emission limitations and operating limitations must I meet if I own or operate a stationary RICE with a site rating of more than 500 brake HP located at a major source of HAP emissions?

**SECTION E. Source Group Restrictions.**

[NA – NOT SUBJECT TO EMISSION OR OPERATING LIMITATIONS]

§ 63.6601 What emission limitations must I meet if I own or operate a new or reconstructed 4SLB stationary RICE with a site rating of greater than or equal to 250 brake HP and less than or equal to 500 brake HP located at a major source of HAP emissions?

[NA – NOT SUBJECT TO EMISSION OR OPERATING LIMITATIONS]

§ 63.6602 What emission limitations and other requirements must I meet if I own or operate an existing stationary RICE with a site rating of equal to or less than 500 brake HP located at a major source of HAP emissions?

[NA – NOT SUBJECT TO EMISSION OR OPERATING LIMITATIONS]

§ 63.6603 What emission limitations, operating limitations, and other requirements must I meet if I own or operate an existing stationary RICE located at an area source of HAP emissions?

Compliance with the numerical emission limitations established in this subpart is based on the results of testing the average of three 1-hour runs using the testing requirements and procedures in § 63.6620 and Table 4 to this subpart. [THERE ARE NO EMISSION LIMITS FOR THE UNITS IN THIS SOURCE GROUP, AND THEREFORE TABLE 4 DOES NOT APPLY]

(a) If you own or operate an existing stationary RICE located at an area source of HAP emissions, YOU MUST COMPLY WITH THE REQUIREMENTS IN TABLE 2d to this subpart and the operating limitations in Table 2b to this subpart that apply to you.

TABLE 2d REQUIREMENTS:

4. For each EMERGENCY STATIONARY CI RICE and black start stationary CI RICE**, you must meet the following requirement, except during periods of startup:

- a. Change oil and filter every 500 hours of operation or annually, whichever comes first*;
- b. Inspect air cleaner every 1,000 hours of operation or annually, whichever comes first, and replace as necessary; and
- c. Inspect all hoses and belts every 500 hours of operation or annually, whichever comes first, and replace as necessary.

5. For each EMERGENCY STATIONARY SI RICE; black start stationary SI RICE; non-emergency, non-black start 4SLB stationary RICE >500 HP that operate 24 hours or less per calendar year; non-emergency, non-black start 4SRB stationary RICE >500 HP that operate 24 hours or less per calendar year**, you must meet the following requirement, except during periods of startup:

- a. Change oil and filter every 500 hours of operation or annually, whichever comes first*;
- b. Inspect spark plugs every 1,000 hours of operation or annually, whichever comes first, and replace as necessary; and
- c. Inspect all hoses and belts every 500 hours of operation or annually, whichever comes first, and replace as necessary.

*Sources have the option to utilize an oil analysis program as described in § 63.6625(i) or (j) in order to extend the specified oil change requirement in Table 2d of this subpart.

**If an emergency engine is operating during an emergency and it is not possible to shut down the engine in order to perform the management practice requirements on the schedule required in Table 2d of this subpart, or if performing the management practice on the required schedule would otherwise pose an unacceptable risk under federal, state, or local law, the management practice can be delayed until the emergency is over or the unacceptable risk under federal, state, or local law has abated. The management practice should be performed as soon as practicable after the emergency has ended or the unacceptable risk under federal, state, or local law has abated. Sources must report any failure to perform the

**SECTION E. Source Group Restrictions.**

management practice on the schedule required and the federal, state or local law under which the risk was deemed unacceptable.

[END OF TABLE 2d REQUIREMENTS]

(b) [NA – EMERGENCY ENGINE(S)]

(c) [NA – EMERGENCY ENGINE(S)]

(d) [NA – EMERGENCY ENGINE(S)]

(e) [NA – EMERGENCY ENGINE(S)]

(f) [NA – EMERGENCY ENGINE(S)]

[75 FR 9675, Mar. 3, 2010, as amended at 75 FR 51589, Aug. 20, 2010; 76 FR 12866, Mar. 9, 2011; 78 FR 6701, Jan. 30, 2013]

§ 63.6604 What fuel requirements must I meet if I own or operate a stationary CI RICE?

(a) [NA – EMERGENCY ENGINE(S)]

(b) Beginning January 1, 2015, if you own or operate an existing emergency CI stationary RICE with a site rating of more than 100 brake HP and a displacement of less than 30 liters per cylinder that uses diesel fuel and operates for the purpose specified in § 63.6640(f)(4)(ii), you must use diesel fuel that meets the requirements in 40 CFR 1090.305 for nonroad diesel fuel, except that any existing diesel fuel purchased (or otherwise obtained) prior to January 1, 2015, may be used until depleted.

(c) [Reserved]

(d) [NA – NOT IN SPECIFIED GEOGRAPHIC LOCATIONS]

[78 FR 6702, Jan. 30, 2013, as amended at 85 FR 78463, Dec. 4, 2020; 87 FR 48607, Aug. 10, 2022]

General Compliance Requirements

§ 63.6605 What are my general requirements for complying with this subpart?

(a) You must be in compliance with the emission limitations, operating limitations, and other requirements in this subpart that apply to you at all times.

(b) At all times you must operate and maintain any affected source, including associated air pollution control equipment and monitoring equipment, in a manner consistent with safety and good air pollution control practices for minimizing emissions. The general duty to minimize emissions does not require you to make any further efforts to reduce emissions if levels required by this standard have been achieved. Determination of whether such operation and maintenance procedures are being used will be based on information available to the Administrator which may include, but is not limited to, monitoring results, review of operation and maintenance procedures, review of operation and maintenance records, and inspection of the source.

[75 FR 9675, Mar. 3, 2010, as amended at 78 FR 6702, Jan. 30, 2013]

Testing and Initial Compliance Requirements

§ 63.6610 By what date must I conduct the initial performance tests or other initial compliance demonstrations if I own or operate a stationary RICE with a site rating of more than 500 brake HP located at a major source of HAP emissions?

[NA – NOT A MAJOR HAP SOURCE]

**SECTION E. Source Group Restrictions.**

§ 63.6611 By what date must I conduct the initial performance tests or other initial compliance demonstrations if I own or operate a new or reconstructed 4SLB SI stationary RICE with a site rating of greater than or equal to 250 and less than or equal to 500 brake HP located at a major source of HAP emissions?

[NA – NOT A MAJOR HAP SOURCE]

§ 63.6612 By what date must I conduct the initial performance tests or other initial compliance demonstrations if I own or operate an existing stationary RICE with a site rating of less than or equal to 500 brake HP located at a major source of HAP emissions or an existing stationary RICE located at an area source of HAP emissions?

[NA – NO PERFORMANCE TESTING REQUIRED]

§ 63.6615 When must I conduct subsequent performance tests?

[NA – NOT SUBJECT TO EMISSION OR OPERATING LIMITATIONS]

§ 63.6620 What performance tests and other procedures must I use?

[NA – NO PERFORMANCE TESTING REQUIRED]

§ 63.6625 What are my monitoring, installation, collection, operation, and maintenance requirements?

(a) [NA – CEMS NOT REQUIRED]

(b) [NA – CPMS NOT REQUIRED]

(c) [NA – LFG NOT USED]

(d) [NA – NOT A MAJOR HAP SOURCE]

(e) If you own or operate any of the following stationary RICE, you must operate and maintain the stationary RICE and after-treatment control device (if any) according to the manufacturer's emission-related written instructions or develop your own maintenance plan which must provide to the extent practicable for the maintenance and operation of the engine in a manner consistent with good air pollution control practice for minimizing emissions:

(1) [NA – NOT A MAJOR HAP SOURCE]

(2) [NA – NOT A MAJOR HAP SOURCE]

(3) An existing emergency or black start stationary RICE located at an area source of HAP emissions;

(4) [NA – EMERGENCY ENGINE(S)]

(5) [NA – EMERGENCY ENGINE(S)]

(6) [NA – EMERGENCY ENGINE(S)]

(7) [NA – EMERGENCY ENGINE(S)]

(8) [NA – EMERGENCY ENGINE(S)]

(9) [NA – EMERGENCY ENGINE(S)]

(10) [NA – EMERGENCY ENGINE(S)]

(f) If you own or operate an existing emergency stationary RICE with a site rating of less than or equal to 500 brake HP located at a major source of HAP emissions or an existing emergency stationary RICE located at an area source of HAP

**SECTION E. Source Group Restrictions.**

emissions, you must install a non-resettable hour meter if one is not already installed.

(g) [NA – EMERGENCY ENGINE(S)]

(h) If you operate a new, reconstructed, or existing stationary engine, you must minimize the engine's time spent at idle during startup and minimize the engine's startup time to a period needed for appropriate and safe loading of the engine, not to exceed 30 minutes, after which time the emission standards applicable to all times other than startup in Tables 1a, 2a, 2c, and 2d to this subpart apply.

(i) If you own or operate a stationary CI engine that is subject to the work, operation or management practices in items 1 or 2 of Table 2c to this subpart or in items 1 or 4 of Table 2d to this subpart, you have the option of utilizing an oil analysis program in order to extend the specified oil change requirement in Tables 2c and 2d to this subpart. The oil analysis must be performed at the same frequency specified for changing the oil in Table 2c or 2d to this subpart. The analysis program must at a minimum analyze the following three parameters: Total Base Number, viscosity, and percent water content. The condemning limits for these parameters are as follows: Total Base Number is less than 30 percent of the Total Base Number of the oil when new; viscosity of the oil has changed by more than 20 percent from the viscosity of the oil when new; or percent water content (by volume) is greater than 0.5. If all of these condemning limits are not exceeded, the engine owner or operator is not required to change the oil. If any of the limits are exceeded, the engine owner or operator must change the oil within 2 business days of receiving the results of the analysis; if the engine is not in operation when the results of the analysis are received, the engine owner or operator must change the oil within 2 business days or before commencing operation, whichever is later. The owner or operator must keep records of the parameters that are analyzed as part of the program, the results of the analysis, and the oil changes for the engine. The analysis program must be part of the maintenance plan for the engine.

(j) If you own or operate a stationary SI engine that is subject to the work, operation or management practices in items 6, 7, or 8 of Table 2c to this subpart or in items 5, 6, 7, 9, or 11 of Table 2d to this subpart, you have the option of utilizing an oil analysis program in order to extend the specified oil change requirement in Tables 2c and 2d to this subpart. The oil analysis must be performed at the same frequency specified for changing the oil in Table 2c or 2d to this subpart. The analysis program must at a minimum analyze the following three parameters: Total Acid Number, viscosity, and percent water content. The condemning limits for these parameters are as follows: Total Acid Number increases by more than 3.0 milligrams of potassium hydroxide (KOH) per gram from Total Acid Number of the oil when new; viscosity of the oil has changed by more than 20 percent from the viscosity of the oil when new; or percent water content (by volume) is greater than 0.5. If all of these condemning limits are not exceeded, the engine owner or operator is not required to change the oil. If any of the limits are exceeded, the engine owner or operator must change the oil within 2 business days of receiving the results of the analysis; if the engine is not in operation when the results of the analysis are received, the engine owner or operator must change the oil within 2 business days or before commencing operation, whichever is later. The owner or operator must keep records of the parameters that are analyzed as part of the program, the results of the analysis, and the oil changes for the engine. The analysis program must be part of the maintenance plan for the engine.

[69 FR 33506, June 15, 2004, as amended at 73 FR 3606, Jan. 18, 2008; 75 FR 9676, Mar. 3, 2010; 75 FR 51589, Aug. 20, 2010; 76 FR 12866, Mar. 9, 2011; 78 FR 6703, Jan. 30, 2013]

§ 63.6630 How do I demonstrate initial compliance with the emission limitations, operating limitations, and other requirements?

(a) You must demonstrate initial compliance with each emission limitation, operating limitation, and other requirement that applies to you according to Table 5 of this subpart. [NA – NONE OF THE CATEGORIES IN TABLE 5 APPLY TO EMERGENCY ENGINES]

(b) [NA – PERFORMANCE TESTING NOT REQUIRED]

(c) [NA – NOCS NOT REQUIRED FOR EXISTING EMERGENCY RICE]

(d) [NA – EMERGENCY ENGINE(S)]

(e) [NA – EMERGENCY ENGINE(S)]

**SECTION E. Source Group Restrictions.**

[69 FR 33506, June 15, 2004, as amended at 78 FR 6704, Jan. 30, 2013]

Continuous Compliance Requirements

§ 63.6635 How do I monitor and collect data to demonstrate continuous compliance?

[NA – NOT SUBJECT TO EMISSION OR OPERATING LIMITATIONS]

§ 63.6640 How do I demonstrate continuous compliance with the emission limitations, operating limitations, and other requirements?

(a) You must demonstrate continuous compliance with each emission limitation, operating limitation, and other requirements in Tables 1a and 1b, Tables 2a and 2b, Table 2c, and Table 2d to this subpart that apply to you according to methods specified in Table 6 to this subpart.

TABLE 6 REQUIREMENTS

9. FOR EACH existing emergency and black start stationary RICE =500 HP located at a major source of HAP, existing non-emergency stationary RICE <100 HP located at a major source of HAP, EXISTING EMERGENCY and black start STATIONARY RICE LOCATED AT AN AREA SOURCE OF HAP, existing non-emergency stationary CI RICE =300 HP located at an area source of HAP, existing non-emergency 2SLB stationary RICE located at an area source of HAP, existing non-emergency stationary SI RICE located at an area source of HAP which combusts landfill or digester gas equivalent to 10 percent or more of the gross heat input on an annual basis, existing non-emergency 4SLB and 4SRB stationary RICE =500 HP located at an area source of HAP, existing non-emergency 4SLB and 4SRB stationary RICE >500 HP located at an area source of HAP that operate 24 hours or less per calendar year, and existing non-emergency 4SLB and 4SRB stationary RICE >500 HP located at an area source of HAP that are remote stationary RICE, complying with the requirement to "Work or Management practices", you must demonstrate continuous compliance by:

i. Operating and maintaining the stationary RICE according to the manufacturer's emission-related operation and maintenance instructions; or

ii. Develop and follow your own maintenance plan which must provide to the extent practicable for the maintenance and operation of the engine in a manner consistent with good air pollution control practice for minimizing emissions.

[END OF TABLE 6 REQUIREMENTS]

(b) [NA – NOT SUBJECT TO EMISSION OR OPERATING LIMITATIONS]

(c) [NA – ANNUAL COMPLIANCE DEMONSTRATION NOT REQUIRED]

(d) [NA – NOT SUBJECT TO EMISSION OR OPERATING LIMITATIONS]

(e) You must also report each instance in which you did not meet the requirements in Table 8 to this subpart that apply to you. If you own or operate a new or reconstructed stationary RICE with a site rating of less than or equal to 500 brake HP located at a major source of HAP emissions (except new or reconstructed 4SLB engines greater than or equal to 250 and less than or equal to 500 brake HP), a new or reconstructed stationary RICE located at an area source of HAP emissions, or any of the following RICE with a site rating of more than 500 brake HP located at a major source of HAP emissions, you do not need to comply with the requirements in Table 8 to this subpart: An existing 2SLB stationary RICE, an existing 4SLB stationary RICE, an existing emergency stationary RICE, an existing limited use stationary RICE, or an existing stationary RICE which fires landfill gas or digester gas equivalent to 10 percent or more of the gross heat input on an annual basis. If you own or operate any of the following RICE with a site rating of more than 500 brake HP located at a major source of HAP emissions, you do not need to comply with the requirements in Table 8 to this subpart, except for the initial notification requirements: a new or reconstructed stationary RICE that combusts landfill gas or digester gas equivalent to 10 percent or more of the gross heat input on an annual basis, a new or reconstructed emergency stationary RICE, or a new or reconstructed limited use stationary RICE. [EXISTING EMERGENCY RICE AT AREA HAP SOURCES ARE NOT AMONG THOSE EXEMPTED FROM THIS SECTION]

**SECTION E. Source Group Restrictions.**

(f) If you own or operate an emergency stationary RICE, you must operate the emergency stationary RICE according to the requirements in paragraphs (f)(1) through (4) of this section. In order for the engine to be considered an emergency stationary RICE under this subpart, any operation other than emergency operation, maintenance and testing, and operation in non-emergency situations for 50 hours per year, as described in paragraphs (f)(1) through (4), is prohibited. If you do not operate the engine according to the requirements in paragraphs (f)(1) through (4), the engine will not be considered an emergency engine under this subpart and must meet all requirements for non-emergency engines.

(1) There is no time limit on the use of emergency stationary RICE in emergency situations.

(2) You may operate your emergency stationary RICE for the purpose specified in paragraph (f)(2)(i) of this section for a maximum of 100 hours per calendar year. Any operation for non-emergency situations as allowed by paragraphs (f)(3) and (4) of this section counts as part of the 100 hours per calendar year allowed by this paragraph (f)(2).

(i) Emergency stationary RICE may be operated for maintenance checks and readiness testing, provided that the tests are recommended by federal, state or local government, the manufacturer, the vendor, the regional transmission organization or equivalent balancing authority and transmission operator, or the insurance company associated with the engine. The owner or operator may petition the Administrator for approval of additional hours to be used for maintenance checks and readiness testing, but a petition is not required if the owner or operator maintains records indicating that federal, state, or local standards require maintenance and testing of emergency RICE beyond 100 hours per calendar year.

(ii)-(iii) [Reserved]

(3) Emergency stationary RICE located at major sources of HAP may be operated for up to 50 hours per calendar year in non-emergency situations. The 50 hours of operation in non-emergency situations are counted as part of the 100 hours per calendar year for maintenance and testing provided in paragraph (f)(2) of this section. The 50 hours per year for non-emergency situations cannot be used for peak shaving or non-emergency demand response, or to generate income for a facility to supply power to an electric grid or otherwise supply power as part of a financial arrangement with another entity.

(4) Emergency stationary RICE located at area sources of HAP may be operated for up to 50 hours per calendar year in non-emergency situations. The 50 hours of operation in non-emergency situations are counted as part of the 100 hours per calendar year for maintenance and testing provided in paragraph (f)(2) of this section. Except as provided in paragraphs (f)(4)(i) and (ii) of this section, the 50 hours per year for non-emergency situations cannot be used for peak shaving or non-emergency demand response, or to generate income for a facility to an electric grid or otherwise supply power as part of a financial arrangement with another entity.

(i) Prior to May 3, 2014, the 50 hours per year for non-emergency situations can be used for peak shaving or non-emergency demand response to generate income for a facility, or to otherwise supply power as part of a financial arrangement with another entity if the engine is operated as part of a peak shaving (load management program) with the local distribution system operator and the power is provided only to the facility itself or to support the local distribution system.

(ii) The 50 hours per year for non-emergency situations can be used to supply power as part of a financial arrangement with another entity if all of the following conditions are met:

(A) The engine is dispatched by the local balancing authority or local transmission and distribution system operator.

(B) The dispatch is intended to mitigate local transmission and/or distribution limitations so as to avert potential voltage collapse or line overloads that could lead to the interruption of power supply in a local area or region.

(C) The dispatch follows reliability, emergency operation or similar protocols that follow specific NERC, regional, state, public utility commission or local standards or guidelines.

(D) The power is provided only to the facility itself or to support the local transmission and distribution system.

(E) The owner or operator identifies and records the entity that dispatches the engine and the specific NERC, regional, state, public utility commission or local standards or guidelines that are being followed for dispatching the engine. The local balancing authority or local transmission and distribution system operator may keep these records on behalf of the engine owner or operator.

**SECTION E. Source Group Restrictions.**

[69 FR 33506, June 15, 2004, as amended at 71 FR 20467, Apr. 20, 2006; 73 FR 3606, Jan. 18, 2008; 75 FR 9676, Mar. 3, 2010; 75 FR 51591, Aug. 20, 2010; 78 FR 6704, Jan. 30, 2013; 87 FR 48607, Aug. 10, 2022]

Notifications, Reports, and Records

§ 63.6645 What notifications must I submit and when?

(a) You must submit all of the notifications in §§ 63.7(b) and (c), 63.8(e), (f)(4) and (f)(6), 63.9(b) through (e), and (g) and (h) that apply to you by the dates specified if you own or operate any of the following;

(1) [NA – NOT A MAJOR HAP SOURCE]

(2) [NA PER (5) BELOW]

(3) [NA – NOT A MAJOR HAP SOURCE]

(4) [NA – NOT A MAJOR HAP SOURCE]

(5) THIS REQUIREMENT DOES NOT APPLY IF YOU OWN OR OPERATE an existing stationary RICE less than 100 HP, AN EXISTING STATIONARY EMERGENCY RICE, OR AN EXISTING STATIONARY RICE THAT IS NOT SUBJECT TO ANY NUMERICAL EMISSION STANDARDS.

(b) [NA – NOT A MAJOR HAP SOURCE]

(c) [NA – NOT A MAJOR HAP SOURCE]

(d) [NA – NOT A MAJOR HAP SOURCE]

(e) [NA – NOT A MAJOR HAP SOURCE]

(f) [NA – 63.6590(b) DOES NOT APPLY]

(g) [NA – PERFORMANCE TEST NOT REQUIRED]

(h) [NA – PERFORMANCE TEST NOT REQUIRED]

(i) [NA – EMERGENCY ENGINE(S)]

[73 FR 3606, Jan. 18, 2008, as amended at 75 FR 9677, Mar. 3, 2010; 75 FR 51591, Aug. 20, 2010; 78 FR 6705, Jan. 30, 2013; 85 FR 73912, Nov. 19, 2020]

§ 63.6650 What reports must I submit and when?

(a) You must submit each report in Table 7 of this subpart that applies to you.

TABLE 7 REQUIREMENTS

4. For each emergency stationary RICE that operate for the purposes specified in § 63.6640(f)(4)(ii), you must submit a Report. The report must contain the information in § 63.6650(h)(1). You must submit the report annually according to the requirements in § 63.6650(h)(2)-(3).

[END OF TABLE 7 REQUIREMENTS]

(b) Unless the Administrator has approved a different schedule for submission of reports under § 63.10(a), you must submit each report by the date in Table 7 of this subpart and according to the requirements in paragraphs (b)(1) through (b)(9) of this section.

**SECTION E. Source Group Restrictions.**

- (1) [NA – ANNUAL REPORT REQUIRED, ONLY UNDER CERTAIN CONDITIONS]
- (2) [NA – ANNUAL REPORT REQUIRED, ONLY UNDER CERTAIN CONDITIONS]
- (3) [NA – ANNUAL REPORT REQUIRED, ONLY UNDER CERTAIN CONDITIONS]
- (4) [NA – ANNUAL REPORT REQUIRED, ONLY UNDER CERTAIN CONDITIONS]
- (5) [NA – ANNUAL REPORT REQUIRED, ONLY UNDER CERTAIN CONDITIONS]
- (6) For annual Compliance reports, the first Compliance report must cover the period beginning on the compliance date that is specified for your affected source in § 63.6595 and ending on December 31.
- (7) For annual Compliance reports, the first Compliance report must be postmarked or delivered no later than January 31 following the end of the first calendar year after the compliance date that is specified for your affected source in § 63.6595.
- (8) For annual Compliance reports, each subsequent Compliance report must cover the annual reporting period from January 1 through December 31.
- (9) For annual Compliance reports, each subsequent Compliance report must be postmarked or delivered no later than January 31.
- (c) [NA – “COMPLIANCE REPORT” NOT REQUIRED]
- (d) [NA – NOT SUBJECT TO EMISSION OR OPERATING LIMITATIONS]
- (e) [NA – NOT SUBJECT TO EMISSION OR OPERATING LIMITATIONS]
- (f) [NA – NOT SUBJECT TO TITLE V PERMITTING]
- (g) [NA – LFG NOT USED]
- (h) If you own or operate an emergency stationary RICE with a site rating of more than 100 brake HP that operates for the purpose specified in § 63.6640(f)(4)(ii), you must submit an annual report according to the requirements in paragraphs (h)(1) through (3) of this section.
 - (1) The report must contain the following information:
 - (i) Company name and address where the engine is located.
 - (ii) Date of the report and beginning and ending dates of the reporting period.
 - (iii) Engine site rating and model year.
 - (iv) Latitude and longitude of the engine in decimal degrees reported to the fifth decimal place.
 - (v)-(vi) [Reserved]
 - (vii) Hours spent for operation for the purpose specified in § 63.6640(f)(4)(ii), including the date, start time, and end time for engine operation for the purposes specified in § 63.6640(f)(4)(ii). The report must also identify the entity that dispatched the engine and the situation that necessitated the dispatch of the engine.
 - (viii) If there were no deviations from the fuel requirements in § 63.6604 that apply to the engine (if any), a statement that there were no deviations from the fuel requirements during the reporting period.
 - (ix) If there were deviations from the fuel requirements in § 63.6604 that apply to the engine (if any), information on the number, duration, and cause of deviations, and the corrective action taken.

**SECTION E. Source Group Restrictions.**

(2) The first annual report must cover the calendar year 2015 and must be submitted no later than March 31, 2016. Subsequent annual reports for each calendar year must be submitted no later than March 31 of the following calendar year.

(3) The annual report must be submitted electronically using the subpart specific reporting form in the Compliance and Emissions Data Reporting Interface (CEDRI) that is accessed through EPA's Central Data Exchange (CDX) (www.epa.gov/cdx). However, if the reporting form specific to this subpart is not available in CEDRI at the time that the report is due, the written report must be submitted to the Administrator at the appropriate address listed in § 63.13.

[69 FR 33506, June 15, 2004, as amended at 75 FR 9677, Mar. 3, 2010; 78 FR 6705, Jan. 30, 2013; 87 FR 48607, Aug. 10, 2022]

§ 63.6655 What records must I keep?

(a) [NA – NOT SUBJECT TO EMISSION OR OPERATING LIMITATIONS]

(b) [NA – NO CEMS OR CPMS]

(c) [NA – LFG NOT USED]

(d) [NA – NOT SUBJECT TO EMISSION OR OPERATING LIMITATIONS]

(e) You must keep records of the maintenance conducted on the stationary RICE in order to demonstrate that you operated and maintained the stationary RICE and after-treatment control device (if any) according to your own maintenance plan if you own or operate any of the following stationary RICE;

(1) [NA – NOT A MAJOR HAP SOURCE]

(2) An existing stationary emergency RICE.

(3) An existing stationary RICE located at an area source of HAP emissions subject to management practices as shown in Table 2d to this subpart.

(f) If you own or operate any of the stationary RICE in paragraphs (f)(1) through (2) of this section, you must keep records of the hours of operation of the engine that is recorded through the non-resettable hour meter. The owner or operator must document how many hours are spent for emergency operation, including what classified the operation as emergency and how many hours are spent for non-emergency operation. If the engine is used for the purpose specified in § 63.6640(f)(4)(ii), the owner or operator must keep records of the notification of the emergency situation, and the date, start time, and end time of engine operation for these purposes.

(1) [NA – NOT A MAJOR HAP SOURCE]

(2) An existing emergency stationary RICE located at an area source of HAP emissions that does not meet the standards applicable to non-emergency engines.

[69 FR 33506, June 15, 2004, as amended at 75 FR 9678, Mar. 3, 2010; 75 FR 51592, Aug. 20, 2010; 78 FR 6706, Jan. 30, 2013; 87 FR 48607, Aug. 10, 2022]

§ 63.6660 In what form and how long must I keep my records?

(a) Your records must be in a form suitable and readily available for expeditious review according to § 63.10(b)(1).

(b) As specified in § 63.10(b)(1), you must keep each record for 5 years following the date of each occurrence, measurement, maintenance, corrective action, report, or record.

(c) You must keep each record readily accessible in hard copy or electronic form for at least 5 years after the date of each occurrence, measurement, maintenance, corrective action, report, or record, according to § 63.10(b)(1).

**SECTION E. Source Group Restrictions.**

[69 FR 33506, June 15, 2004, as amended at 75 FR 9678, Mar. 3, 2010]

Other Requirements and Information

§ 63.6665 What parts of the General Provisions apply to me?

Table 8 to this subpart shows which parts of the General Provisions in §§ 63.1 through 63.15 apply to you. If you own or operate a new or reconstructed stationary RICE with a site rating of less than or equal to 500 brake HP located at a major source of HAP emissions (except new or reconstructed 4SLB engines greater than or equal to 250 and less than or equal to 500 brake HP), a new or reconstructed stationary RICE located at an area source of HAP emissions, or any of the following RICE with a site rating of more than 500 brake HP located at a major source of HAP emissions, you do not need to comply with any of the requirements of the General Provisions specified in Table 8: An existing 2SLB stationary RICE, an existing 4SLB stationary RICE, an existing stationary RICE that combusts landfill or digester gas equivalent to 10 percent or more of the gross heat input on an annual basis, an existing emergency stationary RICE, or an existing limited use stationary RICE. If you own or operate any of the following RICE with a site rating of more than 500 brake HP located at a major source of HAP emissions, you do not need to comply with the requirements in the General Provisions specified in Table 8 except for the initial notification requirements: A new stationary RICE that combusts landfill gas or digester gas equivalent to 10 percent or more of the gross heat input on an annual basis, a new emergency stationary RICE, or a new limited use stationary RICE. [EXISTING EMERGENCY RICE AT AREA HAP SOURCES ARE NOT AMONG THOSE EXEMPTED FROM THIS SECTION]

[75 FR 9678, Mar. 3, 2010]

Individual sources within this source group that are subject to 40 CFR Part 63 Subpart ZZZZ -National Emissions Standards for Hazardous Air Pollutants for Stationary Reciprocating Internal Combustion Engines shall comply with all applicable requirements of the Subpart. 40 CFR 63.13(a) requires submission of copies of all requests, reports and other communications to both the Department and the EPA. The EPA copies shall be forwarded to:

United States Environmental Protection Agency
Region III, Enforcement & Compliance Assurance Division
Air, RCRA and Toxics Branch (3ED21)
Four Penn Center
1600 John F. Kennedy Boulevard
Philadelphia, Pennsylvania 19103-2852

Unless otherwise approved by DEP, the DEP copies shall be reported through the Department's Greenport PUP system available through:

<https://greenport.pa.gov/ePermitPublicAccess/PublicSubmission/Home>

In the event that the Federal Subpart that is the subject of this Source Group is revised, the permittee shall comply with the revised version of the subpart, and shall not be required to comply with any provisions in this permit designated as having the subpart as their authority, to the extent that such permit provisions would be inconsistent with the applicable provisions of the revised subpart.

**SECTION E. Source Group Restrictions.**

Group Name: 005

Group Description: 25 Pa Code Section 129.52d Requirements

Sources included in this group

ID	Name
102A	PAINT BOOTH & WASH PAD - DEPT. 264 NORTH EAST
108	PAINT BOOTH & WASH PAD- DEPT. 264 NORTH WEST
115	PAINT BOOTH SOLVENT USAGE
125	PAINT BOOTH & WASH PAD-DEPT 244 FOOD AND BEVERAGE

I. RESTRICTIONS.

No additional requirements exist except as provided in other sections of this permit including Section B (State Only General Requirements).

II. TESTING REQUIREMENTS.

No additional testing requirements exist except as provided in other sections of this permit including Section B (State Only General Requirements).

III. MONITORING REQUIREMENTS.

No additional monitoring requirements exist except as provided in other sections of this permit including Section B (State Only General Requirements).

IV. RECORDKEEPING REQUIREMENTS.

No additional record keeping requirements exist except as provided in other sections of this permit including Section B (State Only General Requirements).

V. REPORTING REQUIREMENTS.

No additional reporting requirements exist except as provided in other sections of this permit including Section B (State Only General Requirements).

VI. WORK PRACTICE REQUIREMENTS.

No additional work practice requirements exist except as provided in other sections of this permit including Section B (State Only General Requirements).

VII. ADDITIONAL REQUIREMENTS.**# 001 [25 Pa. Code §127.441]****Operating permit terms and conditions.**

[Additional authority for this permit condition was derived from PA 67-05047A]

§ 129.52d. Control of VOC emissions from miscellaneous metal parts surface coating processes, miscellaneous plastic parts surface coating processes and pleasure craft surface coatings.

(a) Applicability.

(1) This section applies to the owner and operator of a miscellaneous metal part surface coating process or miscellaneous plastic part surface coating process, or both, if the total actual VOC emissions from all miscellaneous metal part coating units and miscellaneous plastic part coating units, including related cleaning activities, at the facility are equal to or greater than 2.7 tons per 12-month rolling period, before consideration of controls.

(2) This section applies, as specified, to the owner and operator of a miscellaneous metal part surface coating process or miscellaneous plastic part surface coating process, or both, if the total actual VOC emissions from all miscellaneous metal part coating units and miscellaneous plastic part coating units, including related cleaning activities, at the facility are below 2.7 tons per 12-month rolling period, before consideration of controls.

**SECTION E. Source Group Restrictions.**

(3) Compliance with the VOC emission limits and other requirements of this section assures compliance with the VOC emission limits and other requirements of § 129.52 (relating to surface coating processes) for the miscellaneous metal parts and products surface coating processes as specified in § 129.52, Table I, Category 10.

(4) If an owner or operator elects to comply with § 129.52e (relating to control of VOC emissions from automobile and light-duty truck assembly surface coating operations and heavier vehicle coating operations) under § 129.52e(a)(2) or (3), then § 129.52e instead of this section applies to the separate coating line at the facility, or to the coating of a body or body part for a new heavier vehicle at the facility, or both, for which the election is made.

(5) This section does not apply to an owner or operator in the use or application of the following:

(i) Aerosol coatings that meet the requirements of 40 CFR Part 59, Subpart E (relating to National volatile organic compound emission standards for aerosol coatings).

(ii) Aerospace coatings.

(iii) Architectural coatings.

(iv) Automobile refinishing coatings.

(v) Auto and light-duty truck assembly coatings.

(vi) Can, coil or magnet wire coatings.

(vii) Coating applied to a test panel or coupon, or both, in research and development, quality control or performance testing activities, if records are maintained as required under subsections (e) and (f).

(viii) Fiberglass boat manufacturing materials.

(ix) Flat wood paneling coatings.

(x) Large appliance coatings.

(xi) Metal furniture coatings.

(xii) Miscellaneous industrial adhesives.

(xiii) Paper, film and foil coatings.

(xiv) Shipbuilding and repair coatings.

(xv) Wood furniture coatings.

(b) Definitions. [INCORPORATED BY REFERENCE]

(c) [NA - NO EXISTING RACT PERMIT]

(d) Emission limitations. Beginning January 1, 2017, a person subject to subsection (a)(1) may not cause or permit the emission into the outdoor atmosphere of VOCs from a miscellaneous metal part coating unit or miscellaneous plastic part coating unit, or both, unless emissions of VOCs are controlled in accordance with paragraph (1), (2) or (3).

(1) Compliant materials option. The VOC content of each miscellaneous metal part coating or each miscellaneous plastic part coating, as applied, excluding water and exempt compounds, is equal to or less than the VOC content limit for the applicable coating category specified in the applicable table of VOC content limits in Tables I—V.

**SECTION E. Source Group Restrictions.**

Table I. VOC Content Limits for Metal Parts and Products Surface Coatings Weight of VOC per Volume of Coating, Less Water and Exempt Compounds, as Applied.

Coating Category	Air Dried		Baked	
	kg VOC/ l coating	lb VOC/ gal coating	kg VOC/ l coating	lb VOC/ gal coating
General One-component	0.34	2.8	0.28	2.3
General Multicomponent	0.34	2.8	0.28	2.3
Touch-up and Repair	0.42	3.5	0.36	3.0
Extreme Performance	0.42	3.5	0.36	3.0

[NOTE: FACILITY COATINGS HAVE BEEN APPROVED AS EXTREME PERFORMANCE]

(2)-(3) [NA – NO VOC CONTROL DEVICE]

(4) Least restrictive VOC limit. If more than one VOC content limit or VOC emission rate limit applies to a specific coating, then the least restrictive VOC content limit or VOC emission rate limit applies.

(5) Coatings not listed in Table I, II, VI or VII. For a miscellaneous metal part or miscellaneous plastic part coating that does not meet the coating categories listed in Table I, II, VI or VII, the VOC content limit or VOC emission rate limit shall be determined by classifying the coating as a general one component coating or general multicomponent coating. The corresponding general one component coating or general multicomponent coating limit applies.

(6) Coatings not listed in Table IV or IX. [NA – FACILITY DOES NOT USE PLEASURE CRAFT COATINGS]

(e) Compliance and monitoring requirements.

(1) All owners and operators. Regardless of the facility's VOC emissions, the owner or operator of a miscellaneous metal part surface coating process or miscellaneous plastic part surface coating process, or both, subject to subsection (a)(1) or (2), shall comply with this section as specified throughout this section. For an owner or operator subject only to subsection (a)(2), the compliance requirements are the recordkeeping requirements in subsection (f)(2).

(2) [NA – NO VOC CONTROL DEVICE]

(f) Recordkeeping and reporting requirements.

(1) The owner or operator of a miscellaneous metal part coating unit or miscellaneous plastic part coating unit, or both, subject to subsection (a)(1) shall maintain monthly records sufficient to demonstrate compliance with this section. The records must include the following information:

(i) The following parameters for each coating, thinner, component and cleaning solvent as supplied:

(A) Name and identification number of the coating, thinner, other component or cleaning solvent.

(B) Volume used.

(C) Mix ratio.

(D) Density or specific gravity.

(E) Weight percent of total volatiles, water, solids and exempt solvents.

(F) Volume percent of total volatiles, water and exempt solvents for the applicable table of limits in Tables I—V.

(G) Volume percent of solids for the applicable table of limits in Tables VI—IX.

**SECTION E. Source Group Restrictions.**

- (ii) The VOC content of each coating, thinner, other component and cleaning solvent as supplied.
 - (iii) The VOC content of each as applied coating or cleaning solvent.
 - (iv) The calculations performed for each applicable requirement under subsections (d) and (e).
 - (v) The information required in a plan approval issued under subsection (e)(2).
- (2) An owner or operator subject to subsection (a)(2), or otherwise claiming an exemption or exception in this section, shall maintain records sufficient to verify the applicability of subsection (a)(2), the exemption or exception. Records maintained for compliance demonstrations may include purchase, use, production and other records.
- (3) The records shall be maintained onsite for 2 years, unless a longer period is required by an order, plan approval or operating permit issued under Chapter 127 (relating to construction, modification, reactivation and operation of sources).
- (4) The records shall be submitted to the Department in an acceptable format upon receipt of a written request from the Department.
- (g) Coating application methods. A person subject to subsection (a)(1) may not cause or permit the emission into the outdoor atmosphere of VOCs from a miscellaneous metal part coating unit or miscellaneous plastic part coating unit, or both, unless the coatings are applied using one or more of the following coating application methods:
- (1) Electrostatic coating.
 - (2) Flow coating.
 - (3) Dip coating, including electrodeposition.
 - (4) Roll coating.
 - (5) High volume-low pressure (HVLP) spray coating.
 - (6) Airless spray coating.
 - (7) Air-assisted airless spray coating.
 - (8) Other coating application method if approved in writing by the Department prior to use.
- (i) The coating application method must be capable of achieving a transfer efficiency equivalent to or better than that achieved by HVLP spray coating.
- (ii) The owner or operator shall submit the request for approval to the Department in writing.
- (h) Exempt coatings and exempt coating unit operations.
- (1) The requirements of subsections (d) and (g) do not apply to the application of the following coatings to a metal part:
- (i) Stencil coating.
 - (ii) Safety-indicating coating.
 - (iii) Solid-film lubricant.
 - (iv) Electric-insulating and thermal-conducting coating.
 - (v) Magnetic data storage disk coating.

**SECTION E. Source Group Restrictions.**

- (vi) Plastic extruded onto metal parts to form a coating.
- (vii) Powder coating.
- (2) The requirements of subsection (d) do not apply to the application of the following coatings to a plastic part:
 - (i) Touch-up and repair coating.
 - (ii) Stencil coating applied on a clear or transparent substrate.
 - (iii) Clear or translucent coating.
 - (iv) Coating applied at a paint manufacturing facility while conducting performance tests on coating.
 - (v) Reflective coating applied to highway cones.
 - (vi) Mask coating, if the coating is less than 0.5 millimeter thick (dried) and the area coated is less than 25 square inches.
 - (vii) EM/RFI shielding coating.
 - (viii) Heparin-benzalkonium chloride (HBAC)-con-taining coating applied to a medical device, provided that the total usage of HBAC-containing coatings does not exceed 100 gallons in 1 calendar year at the facility.
 - (ix) Powder coating.
 - (x) An individual coating category used in an amount less than 50 gallons in 1 calendar year provided that the total usage of all of the coatings, combined, does not exceed 200 gallons per year at the facility. This exception applies only if substitute compliant coatings are not available.
- (3) The requirements of subsection (d) do not apply to the application of the following coatings to automotive-transportation and business machine parts:
 - (i) Texture coat.
 - (ii) Vacuum-metalizing coating.
 - (iii) Gloss reducer.
 - (iv) Texture topcoat.
 - (v) Adhesion primer.
 - (vi) Electrostatic prep coat.
 - (vii) Resist coating.
 - (viii) Stencil coating.
 - (ix) Powder coating.
- (4) The requirements of subsection (g) do not apply to the following activities:
 - (i) Application of a touch-up coating, repair coating or textured finish to a metal part.
 - (ii) Application of a powder coating to the following:
 - (A) Plastic part.

**SECTION E. Source Group Restrictions.**

- (B) Automotive-transportation plastic part.
- (C) Business machine plastic part.
- (iii) Airbrush application of coating to a metal part or plastic part using no more than 5 gallons of coating per year.
- (iv) Use of an add-on air pollution control device to comply with subsection (d).
- (v) Application of extreme high-gloss coating in a pleasure craft surface coating operation.
- (i) Work practice requirements for coating-related activities. The owner or operator of a miscellaneous metal part coating unit or miscellaneous plastic part coating unit, or both, subject to subsection (a)(1) shall comply with the following work practices for coating-related activities:
 - (1) Store all VOC-containing coatings, thinners or coating-related waste materials in closed containers.
 - (2) Ensure that mixing and storage containers used for VOC-containing coatings, thinners or coating-related waste materials are kept closed at all times, except when depositing or removing these coatings, thinners or waste materials.
 - (3) Minimize spills of VOC-containing coatings, thinners or coating-related waste materials and clean up spills immediately.
 - (4) Convey VOC-containing coatings, thinners or coating-related waste materials from one location to another in closed containers or pipes.
- (j) Work practice requirements for cleaning materials. The owner or operator of a miscellaneous metal part coating unit or miscellaneous plastic part coating unit subject to subsection (a)(1) shall comply with the following work practices for cleaning materials:
 - (1) Store all VOC-containing cleaning materials and used shop towels in closed containers.
 - (2) Ensure that mixing vessels and storage containers used for VOC-containing cleaning materials are kept closed at all times except when depositing or removing these materials.
 - (3) Minimize spills of VOC-containing cleaning materials and clean up spills immediately.
 - (4) Convey VOC-containing cleaning materials from one location to another in closed containers or pipes.
 - (5) Minimize VOC emissions from cleaning of application, storage, mixing or conveying equipment by ensuring that equipment cleaning is performed without atomizing the cleaning solvent and all spent solvent is captured in closed containers.
- (k) Measurements and calculations. To determine the properties of a coating or component used in a miscellaneous metal parts surface coating process or miscellaneous plastic parts surface coating process, measurements and calculations shall be performed according to one or more of the following:
 - (1) EPA Reference Method 24, Determination of Volatile Matter Content, Water Content, Density, Volume Solids, and Weight Solids of Surface Coatings, found at 40 CFR Part 60, Subpart D, Appendix A, including updates and revisions.
 - (2) Manufacturer's formulation data.
 - (3) Sampling and testing done in accordance with the procedures and test methods specified in Chapter 139.
 - (4) Other test method demonstrated to provide results that are acceptable for purposes of determining compliance with this section if prior approval is obtained in writing from the Department.
 - (5) [NA – NO VOC CONTROL DEVICE]

**SECTION E. Source Group Restrictions.**

(6) EPA calculations information in the following:

(i) A Guideline for Surface Coating Calculations, EPA-340/1-86-016, including updates and revisions.

(ii) Procedures for Certifying Quantity of Volatile Organic Compounds Emitted by Paint, Ink, and Other Coatings, EPA-450/3-84-019, including updates and revisions.

002 [25 Pa. Code §127.441]

Operating permit terms and conditions.

Corrosion preventative coatings applied, and subsequent use of solvents are subject to this source group requirements, except that the term "coatings" does not include protective oils, acids or bases, or combinations of these materials.



SECTION F. Alternative Operation Requirements.

No Alternative Operations exist for this State Only facility.



SECTION G. Emission Restriction Summary.

No emission restrictions listed in this section of the permit.

**SECTION H. Miscellaneous.**

NOTE: The capacities listed in Section A, page 4 are for informational use only and should not be used as enforceable limitations.

The following sources and activities are not subject to any emission limitations, restrictions, work practice standards, testing, monitoring, recordkeeping or reporting requirements:

1. Air conditioning and ventilation systems
2. Office equipment (copiers, printers, FAX, etc.)
3. Janitorial equipment
4. Building demolition and construction
5. Plant maintenance
6. Rust inhibitor dip tank
7. Machine shop large parts washer (detergent)
8. Electric machine tools
9. Storage tanks (including propane, gasoline, diesel, fuel oil, kerosene, xylene, oxygen, argon)
10. Vacuum pumps
11. Air drier condensate water boil-off tank
12. Ground water aeration
13. Washdown booth (detergent)
14. Mobile sources (trucks, forklifts, snowblowers, etc.)
15. Natural gas fired space heaters
16. Laser cutter and interior baghouse control per RFD 10387 (11/2/23)
17. AcuAir line application of insulating foam per RFD 10387 (11/2/23)
18. Insulating foam use
19. Storage building hot water heater (0.32 mmBtu/hr natural gas)
20. Water tank heater (0.5 mmBtu/hr natural gas)
21. Flame hardener (0.2 mmBtu/hr natural gas)
22. Machining and lubricant usage.
23. Shwarf and chip processing
24. oil water seperater/permeater room
25. testing of heating elements using natural gas
26. R&D ammonia closed loop system
27. Nitrogen generation system
28. (2) Vacu-blast handheld shotblast units with filters, indoor venting.

This permit renewal includes the sources & conditions of Plan Approval No. 28-05047A which was issued March 13, 2018 and expires on 9/31/19. This permit renewal supersedes the Plan Approval No. 28-05047A.



***** End of Report *****
